



# 5555MX

## Surface Mount Device

### Applications

- High-end architectural lighting
- Photographic/broadcast lighting
- Stage lighting
- Accent lighting
- Advertising lighting
- Photoelectric device and relevant research

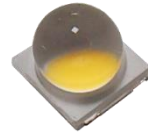

### Features

- Industrial high CRI performance of white light
- Full-color gamut of red, green and blue
- 60° optical lens
- 5.5mm × 5.5mm package
- TLCI & TM-30 specified (white light)
- SimpleBinning solution (white light)

### [About Yujileads<sup>®</sup>](#)

Rev Version: 2.3

P3190004.00

## Table of Contents

<b>General description .....</b>	<b>4</b>
<b>Ordering information .....</b>	<b>8</b>
<b>Characteristics .....</b>	<b>9</b>
Electrical-optical characteristics ( $T_A = 25^\circ\text{C}$ , 150mA) .....	9
Absolute maximum ratings ( $T_A = 25^\circ\text{C}$ ) .....	10
<b>Chromaticity group and diagram .....</b>	<b>11</b>
Chromaticity bins & coordinates .....	11
CIE 1931 diagram.....	11
<b>Reliability .....</b>	<b>12</b>
<b>Package material and dimension.....</b>	<b>13</b>
Package layout.....	13
Package materials.....	13
<b>Characteristic graph .....</b>	<b>14</b>
Typical spectral power distribution (normalized).....	14
Forward current.....	16
Vs. forward voltage.....	16
Vs. relative luminous flux.....	16
Vs. relative chromaticity shift .....	17
Vs. absolute chromaticity shift .....	17
Derating based on solder point .....	17
Solder point temperature ( $T_s$ ).....	18
Vs. forward voltage.....	18
Vs. relative chromaticity shift .....	18
Vs. absolute chromaticity shift .....	18
Spatial distribution ( $T_A = 25^\circ\text{C}$ , $I_F = 150\text{mA}$ ).....	19
<b>Solder and reflow profile .....</b>	<b>21</b>
Recommended solder pad layout.....	21
Reflow profile.....	21
<b>SMT instruction .....</b>	<b>22</b>
Problems caused by improper selection of collet.....	22

---

Collet selection.....	22
Other notes of caution.....	22
<b>Tape and reel specifications .....</b>	<b>23</b>
<b>Box packaging .....</b>	<b>25</b>
<b>About Yujileds .....</b>	<b>26</b>

## General description

The 5555 series LED is the combination of a typical SMD (Surface Mounted Device) LED with a silicon lens. With the PCT lead frame, optimized LED phosphor solution and silicon lens, the 5555 series is robust for long-time working. It offers not only promising maintenance of brightness, but also the consistent color which is required critically in many different applications with excellent **Reliability**.

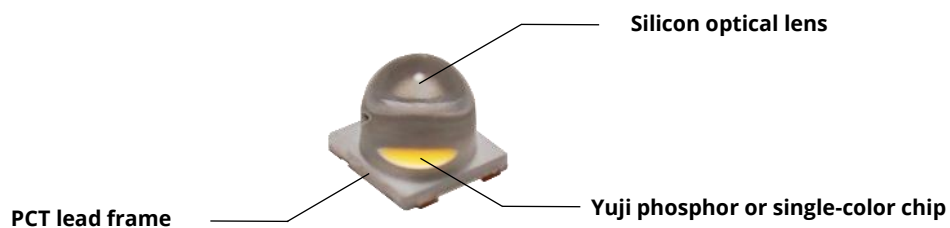

The 60° lens (Blue light 55°) offers a significant effect for focused light with increased illuminance compared to a standard 120° SMD LED. And the high color rendition feature with accurate color consistency makes the 5555 series LED an ideal solution for photographic and cinematography lighting for creating the “hard light”.



The spatial distribution of a standard SMD LED with 120° beam angle.

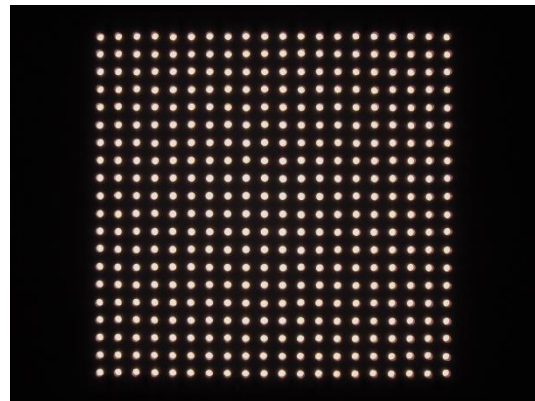

The spatial distribution of 5555 series LED with 60° beam angle.

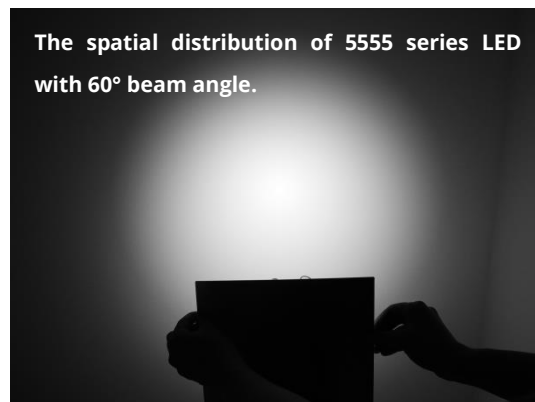
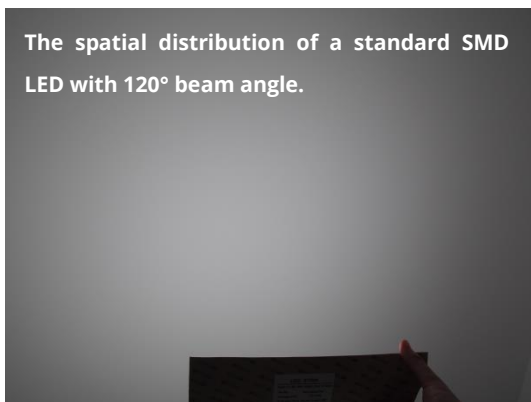

**Consistent chromaticity for both RGB and white light**

All 5555 series white light products based on the Yujileds® BC technology, it brings high color rendering quality, and with the SimpleBinning technology, the white lights are < 3-step equivalent SDCM.

**Industrial-leading high CRI technology**

Yujileds® BC technology is based on the efficient blue (typical 450nm) die, mixing with Yuji advanced phosphors and specifically designed spectral recipes. Although there are more and more nominal “high CRI LED” manufacturers on the market, after relevant test and analysis, it is proud to say that Yujileds® BC technology is still one of the top performance product on the global markets. Achieving typical Ra 97 and minimum Ra 95, the stability and consistent quality in mass production are verified by statistical identification.

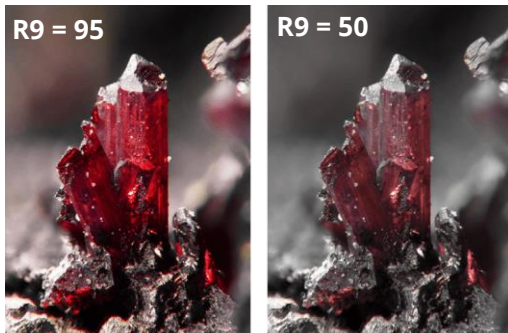
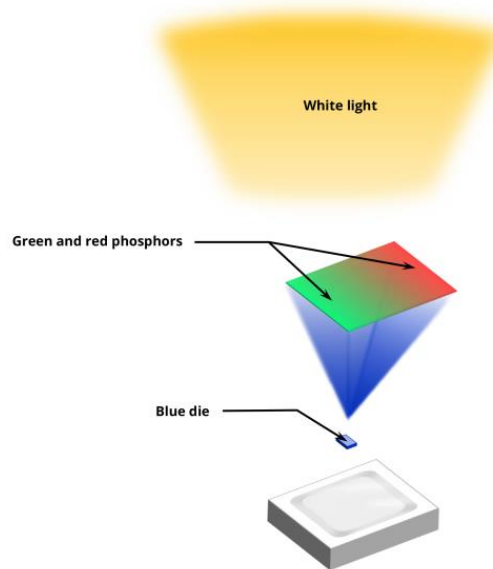

Light source	R9
Halogen (2865K)	99
Fluorescent (3000K)	-27
Standard LED (3000K)	13
Yujileds® BC series LED (3000K)	96

**Enhanced CRI R9 technology**

The standard CRI Ra is the average score of the first eight Test Color Samples (TCS), where the 9th for saturated red color is missed. However R9 is significantly different for different light sources. In spectral analysis and CRI arithmetic, the integral area between the spectrum and the spectral reflectance response of TCS-9 decides the R9 to a large extent – in other words, how much of TCS-9 spectra reflectance is overlaid in the light source spectrum, that is a key factor.

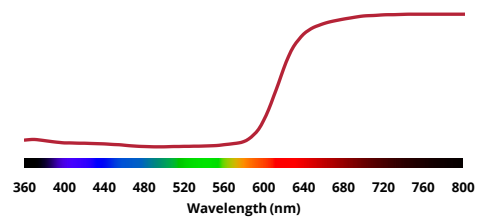

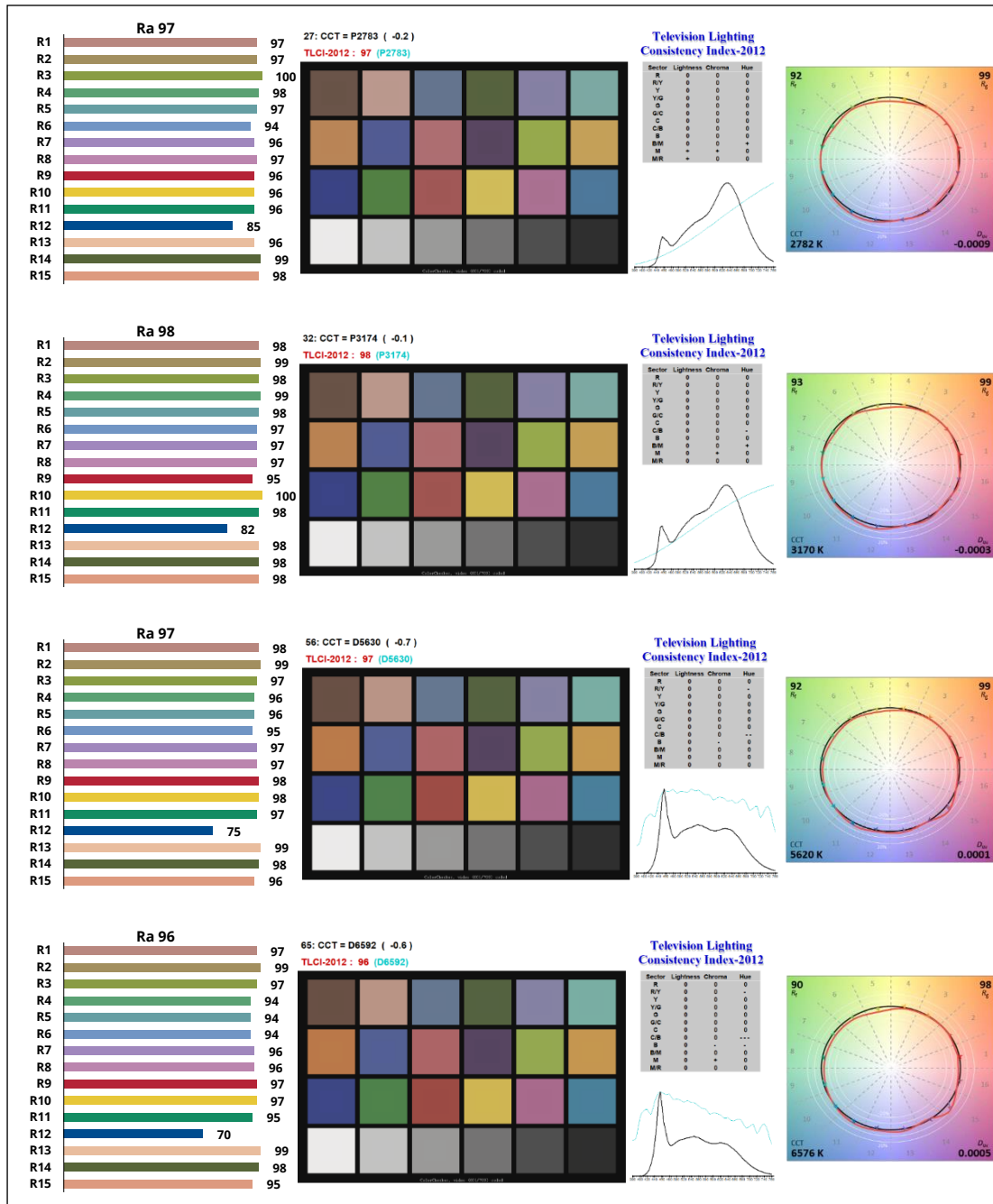

The RGB color of the Yujileds® 5555 series provides 5nm tolerance (or up to 2.5nm within a batch) for the ultimate pursuit of chromaticity consistency. The combination of three colors achieves an extraordinary wide color gamut and thus is more flexible for sophisticated color combinations for applications such as stage effect or accent lighting.

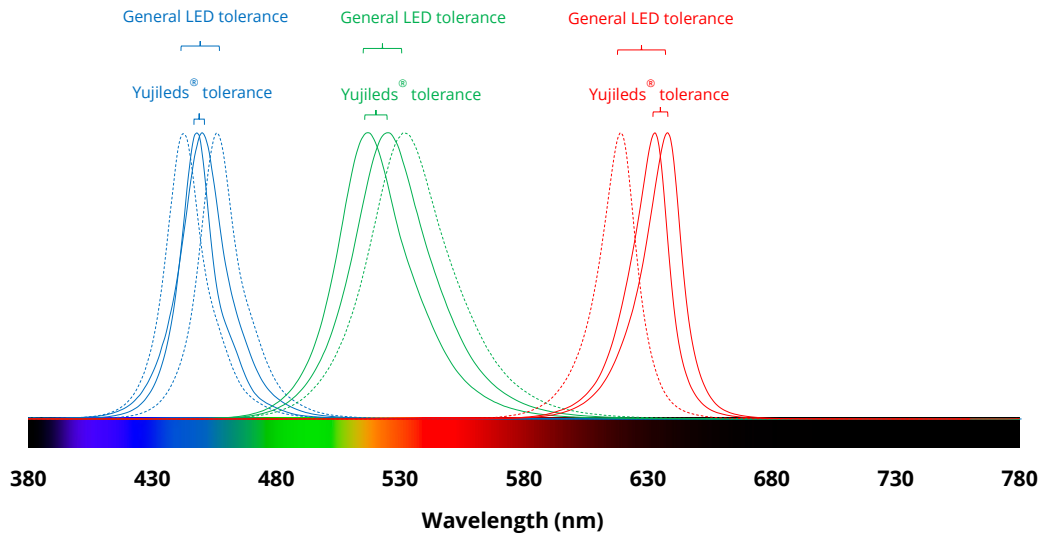

The 5555MX series also supports the unique service/certification by Yujileds® as described below.



**TM-30**  
Specified

**TM-30-18 specification (white light)**

The most advanced colorimetric for color rendition, widely recognized as the successor of CRI.



**TLCI**  
Specified

**TLCI specification (white light)**

Based on the Macbeth ColorChecker, for evaluating the colorimetric quality of the broadcast lighting.



**Simple Binning**

**SimpleBinning specification (white light)**

Simplify the chromaticity binning with TrueChroma data support to provide the most economical, simple, and practical solution to customers.



**RoHS**  
Compliance

**RoHS 2011/65/EU compliance**

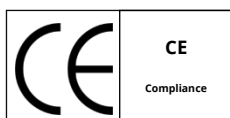

**CE**  
Compliance

**CE compliance**



**REACH**  
Compliance

**REACH compliance (Phosphor)**

## Ordering information

PART NUMBER	PRODUCT CODE	CCT/COLOR	CHROMATICITY BINS	VOLTAGE RANGE
<b>YJ-BC-5555MX-G02-27</b>	P3190004.27	2700K	27L, 27R	0.1V
<b>YJ-BC-5555MX-G02-32</b>	P3190004.32	3200K	29M, 31M, 32M	0.1V
<b>YJ-BC-5555MX-G02-56</b>	P3190004.56	5600K	49M, 52M, 55M, 58M	0.1V
<b>YJ-BC-5555MX-G02-65</b>	P3190004.65	6500K	65L, 65R	0.1V
<b>YJ-5555MX-R620</b>	P3190004.01	Red	-	0.1V
<b>YJ-5555MX-G520</b>	P3190004.02	Green	-	0.1V
<b>YJ-5555MX-B460</b>	P3190004.03	Blue	-	0.1V
<b>YJ-5555MX-XX</b>	P3190004.XX	Custom	-	0.1V



## Characteristics

Electrical-optical characteristics ( $T_A = 25^\circ\text{C}$ , 150mA)

COLOR	PARAMETER	SYMBOL	VALUE			UNIT
			MIN.	TYP.	MAX.	
White	Forward voltage	$V_F$	3.0	-	3.4	V
	Luminous Flux	$\Phi_{2700K}$	47	-	54	lm
		$\Phi_{3200K}$	47	-	54	
		$\Phi_{5600K}$	56	-	63	
		$\Phi_{6500K}$	56	-	63	
	Correlated color temperature <sup>(1)</sup>	$CCT_{2700K}$	2580	2700	2820	K
		$CCT_{3200K}$	2900	3200	3320	
		$CCT_{5600K}$	4800	5600	6000	
		$CCT_{6500K}$	6100	6500	6900	
	Color rendering index	$R_a$	95 <sup>(2)</sup>	-	-	-
	TCS R9 (CRI red)	R9	-	90	-	-
	Fidelity index <sup>(3)</sup>	$R_f$	-	92	-	-
	Gamut index <sup>(3)</sup>	$R_g$	-	100	-	-
	TLCI 2012 <sup>(4)</sup>	-	-	97	-	-
	Reverse current	$I_r$	-	-	1	$\mu\text{A}$
View angle <sup>(5)</sup>	$2\theta_{1/2}$	-	60	-	Deg	
Red	Forward voltage	$V_F$	1.9	-	2.5	V
	Luminous flux	$\Phi$	24	-	30	lm
	Dominant wavelength <sup>(1)</sup>	$\lambda_D$	619	-	625	nm
	Peak wavelength <sup>(1)</sup>	$\lambda_P$	-	630	-	nm
	View angle <sup>(5)</sup>	$2\theta_{1/2}$	-	60	-	Deg
	Reverse current	$I_r$	-	-	5	$\mu\text{A}$
	Thermal resistance <sup>(5)</sup>	$R_{\theta JS}$	-	10	-	$^\circ\text{C/W}$
Green	Forward voltage	$V_F$	2.8	-	3.6	V
	Luminous flux	$\Phi$	48	-	58	lm
	Dominant wavelength <sup>(1)</sup>	$\lambda_D$	515	-	525	nm
	Peak wavelength <sup>(1)</sup>	$\lambda_P$	-	514	-	nm
	View angle <sup>(5)</sup>	$2\theta_{1/2}$	-	60	-	Deg
	Reverse current	$I_r$	-	-	5	$\mu\text{A}$
Thermal resistance <sup>(5)</sup>	$R_{\theta JS}$	-	10	-	$^\circ\text{C/W}$	
Blue	Forward voltage	$V_F$	3.0	-	3.4	V
	Luminous flux	$\Phi$	10.5	-	13.5	lm
	Dominant wavelength <sup>(1)</sup>	$\lambda_D$	455	-	460	nm
	Peak wavelength <sup>(1)</sup>	$\lambda_P$	-	453	-	nm
	View angle <sup>(5)</sup>	$2\theta_{1/2}$	-	55	-	Deg
	Reverse current	$I_r$	-	-	5	$\mu\text{A}$

<b>Thermal resistance<sup>(5)</sup></b>	$R_{\theta JS}$	-	12	-	°C/W
---	-----------------	---	----	---	------

- (1). Yujileds® promises the chromaticity coordinate tolerance of  $\pm 0.0015$  (CIE 1931 x,y) based on Yuji standard equipment shall prevail.
- (2). Ra typical 95 at 6500K.
- (3). Defined by the IES TM-30-18 method, this data is for trial.
- (4). Defined by the EBU, TLCI is the abbreviation of Television Lighting Consistency Index, this data is for trial.
- (5). This data is for reference only.

Absolute maximum ratings ( $T_A = 25^\circ\text{C}$ )

PARAMETER	SYMBOL	WHITE	RED	GREEN	BLUE	UNIT
<b>Power Consumption</b>	$P_D$	630	500	500	500	mW
<b>DC Forward Current (pulsed)<sup>(1)</sup></b>	$I_{FP}$	360 <sup>(2)</sup>	200 <sup>(2)</sup>	200 <sup>(2)</sup>	200 <sup>(2)</sup>	mA
<b>DC Forward Current</b>	$I_F$	180	180	180	180	mA
<b>Reverse Voltage</b>	$V_R$	5	10	5	5	V
<b>Junction Temperature</b>	$T_j$	125	115	125	125	°C
<b>Solder Point Temperature<sup>(3)</sup></b>	$T_s$			105		°C
<b>Operating Temperature</b>	$T_{opr}$			-40 ~ +85		°C
<b>Storage Temperature</b>	$T_{stg}$			-30 ~ +85		°C
<b>Soldering Temperature</b>	$T_{sol}$			210 $\pm$ 5(<10sec)		°C
<b>Reflow Cycles Allowed</b>	-			2		-

- (1). Pulse width  $\leq 0.1\text{ms}$ , duty  $\leq 1/10$ .
- (2). Theoretical data.
- (3). See page [Package material and dimension](#).

## Chromaticity group and diagram

### Chromaticity bins & coordinates

CCT	BIN	CIE 1931 COORDINATES							
		X0	Y0	X1	Y1	X2	Y2	X3	Y3
2700K	27L	0.4542	0.4166	0.4459	0.4005	0.4552	0.4025	0.4642	0.4185
	27R	0.4642	0.4185	0.4552	0.4025	0.4652	0.4043	0.4749	0.4203
3200K	29M	0.4371	0.4105	0.4297	0.3945	0.4403	0.3985	0.4483	0.4143
	31M	0.4269	0.4069	0.4200	0.3909	0.4297	0.3945	0.4371	0.4105
	33M	0.4194	0.4042	0.4130	0.3882	0.4200	0.3909	0.4269	0.4069
5600K	49M	0.3450	0.3610	0.3440	0.3420	0.3502	0.3473	0.3517	0.3657
	52M	0.3450	0.3610	0.3440	0.3420	0.3344	0.3330	0.3347	0.3520
	55M	0.3260	0.3430	0.3270	0.3250	0.3344	0.3330	0.3347	0.3520
	58M	0.3205	0.3385	0.3224	0.3210	0.3270	0.3250	0.3260	0.3430
6500K	65L	0.3067	0.3235	0.3088	0.3121	0.3143	0.3178	0.3128	0.3295
	65R	0.3128	0.3295	0.3143	0.3178	0.3205	0.3241	0.3192	0.3359

### CIE 1931 diagram

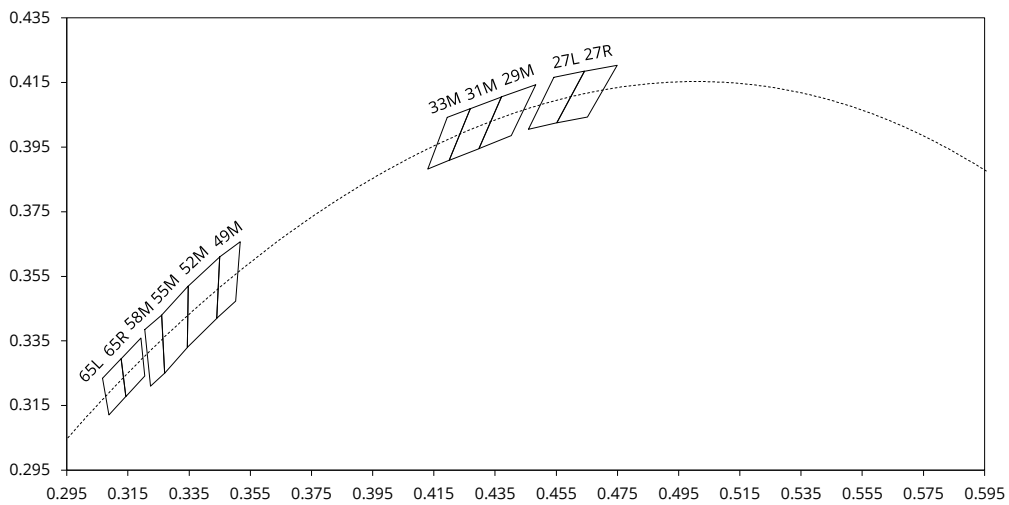

## Reliability<sup>(1)</sup>

$T_s = 55^\circ\text{C}$ ,  $I_F = 300\text{mA}$ ,  $\text{RH} < 65\%$ , calculate  $L_{70} > 54000$  hours<sup>(2)</sup>

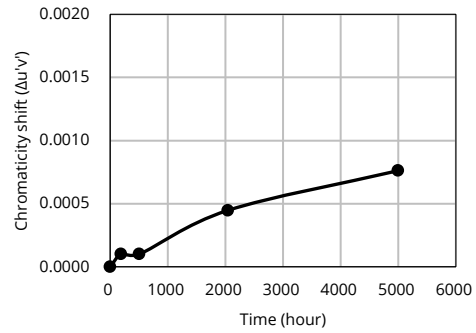
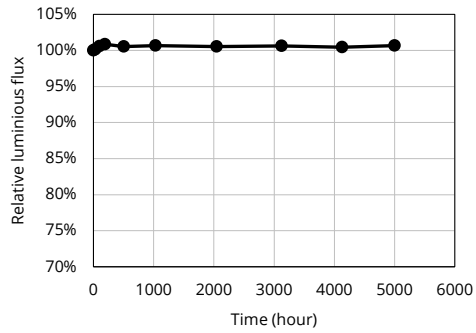

(1). Data from Yujileds<sup>®</sup> lab, based on the average test of YJ-BC-5555HX-G02-56.

(2). Yujileds<sup>®</sup> reserves all the right for final explanation of reliability.

## Package material and dimension

### Package layout

All dimensions in mm, tolerance unless mentioned is  $\pm 0.1$ mm.

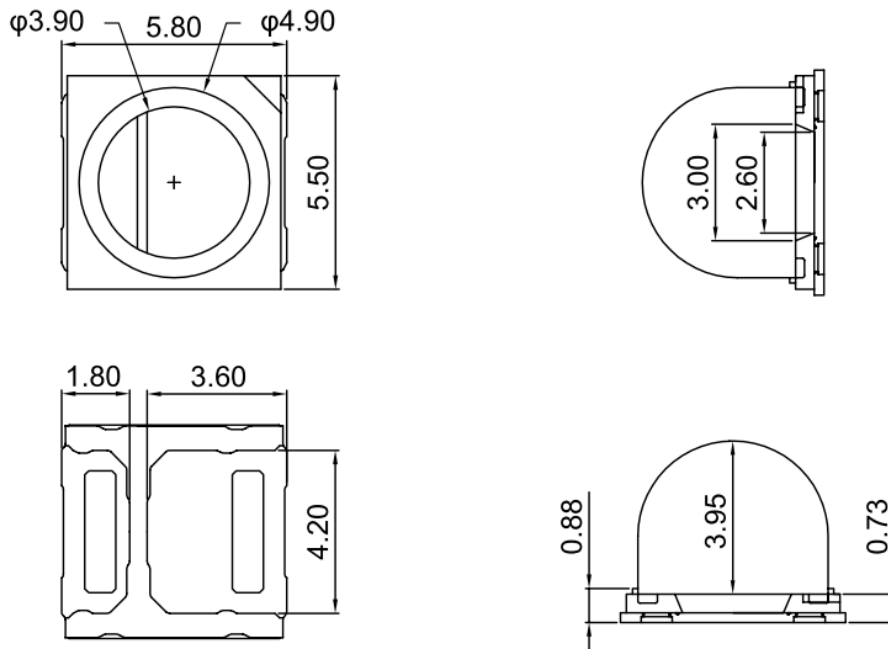

### Package materials

ITEM	DESCRIPTION
<b>Die material</b>	InGaN (white and blue), AlGaInP (red), GaN (green)
<b>Lead frame material</b>	PCT
<b>Encapsulant resin material</b>	Silicon + Phosphor (white)
<b>Electrodes material</b>	Silver-plated copper

## Characteristic graph

Typical spectral power distribution (normalized)

All characteristic curves are for reference only and not guaranteed.

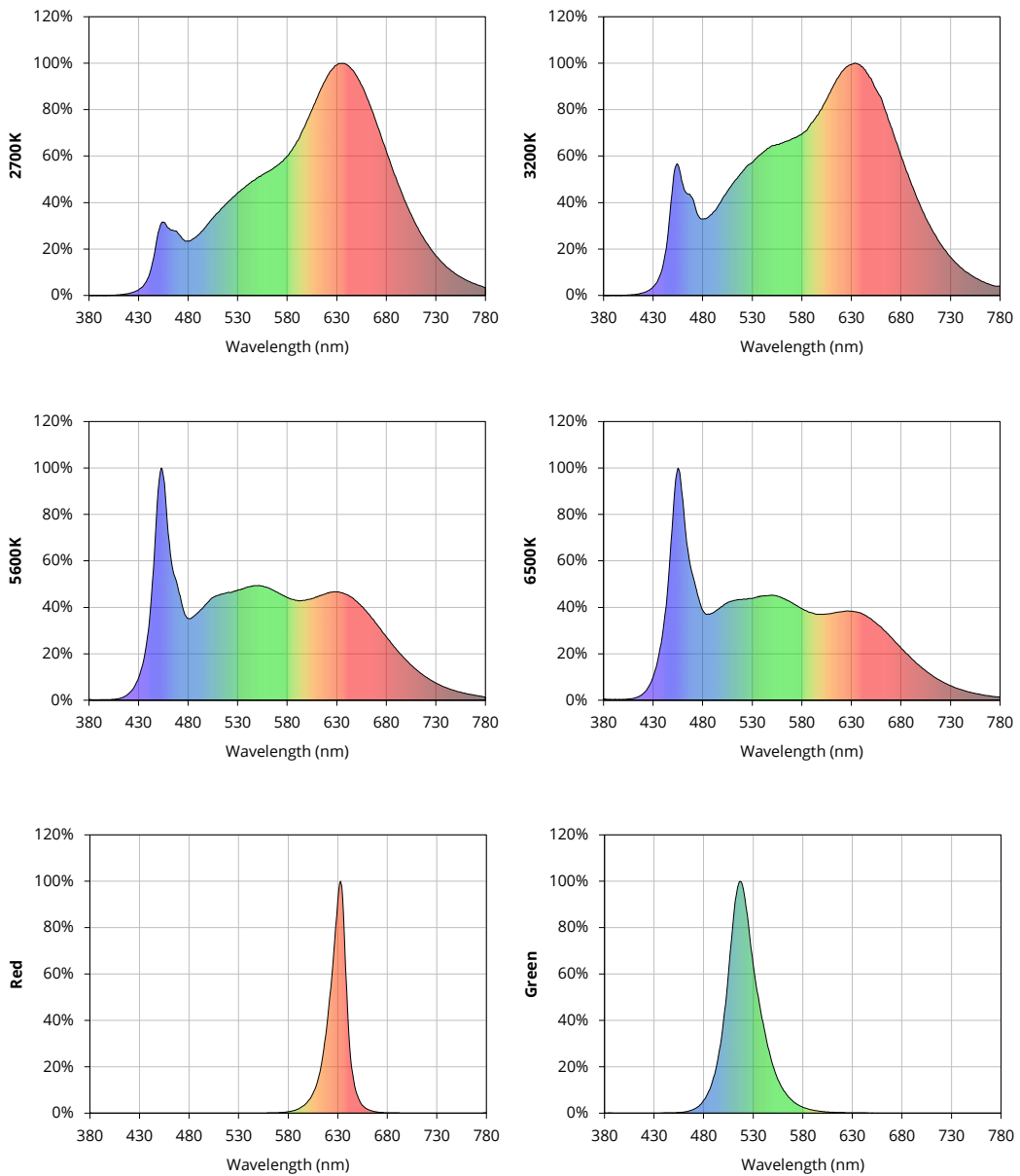

## Characteristic graph

Typical spectral power distribution (normalized) (continued)

All characteristic curves are for reference only and not guaranteed.

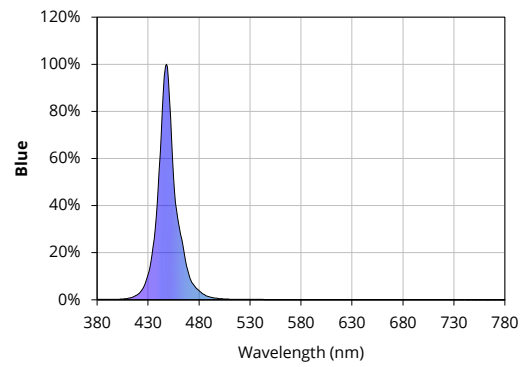

## Characteristic graph

### Forward current (white light)

All characteristic curves are for reference only and not guaranteed.

Vs. forward voltage

( $T_A = 25^\circ\text{C}$ )

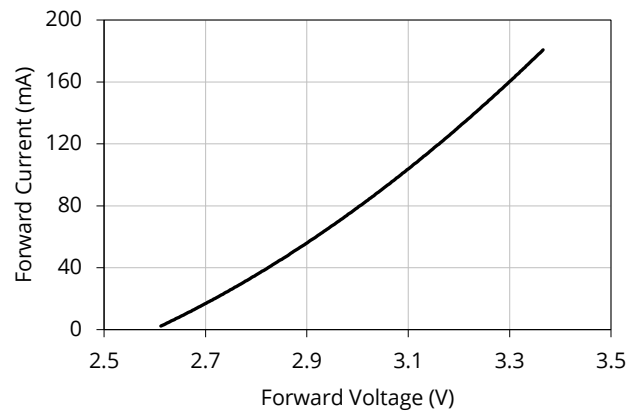

Vs. relative luminous flux

( $T_A = 25^\circ\text{C}$ )

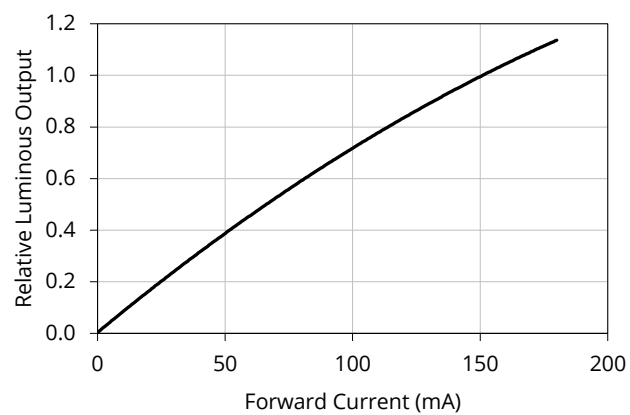



## Characteristic graph

### Forward current (white light) (continued)

All characteristic curves are for reference only and not guaranteed.

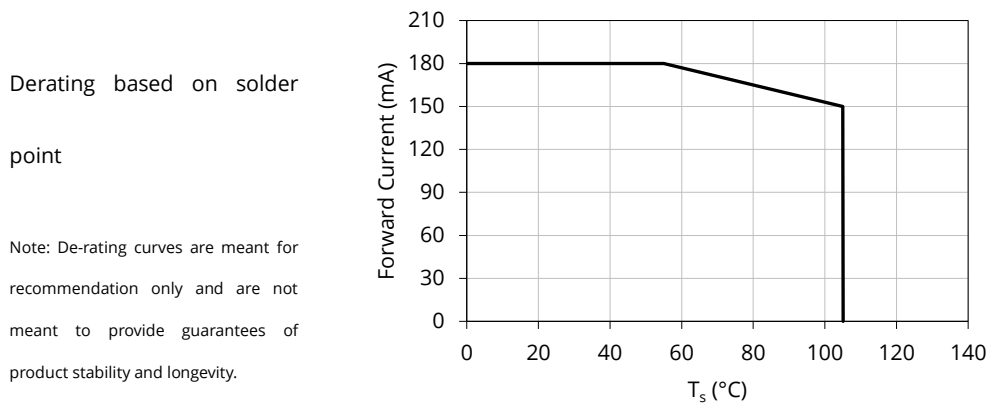
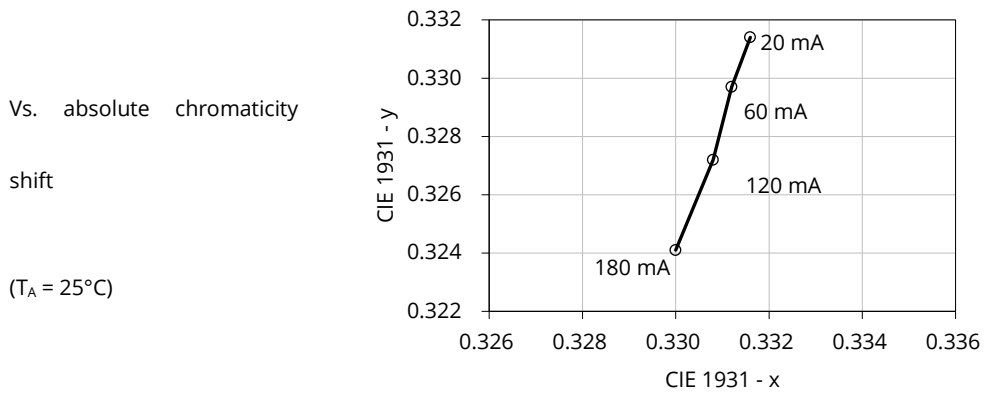
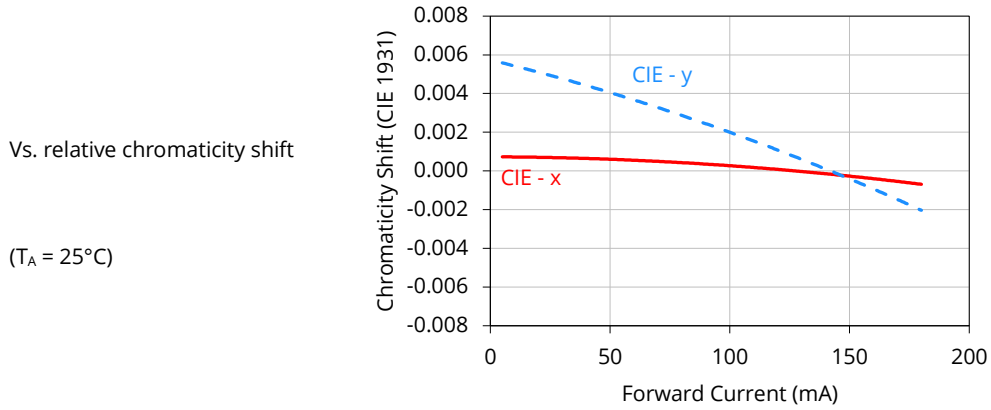

Solder point temperature ( $T_s$ ) (white light)

All characteristic curves are for reference only and not guaranteed.

Vs. forward voltage

( $I_F = 150\text{mA}$ )

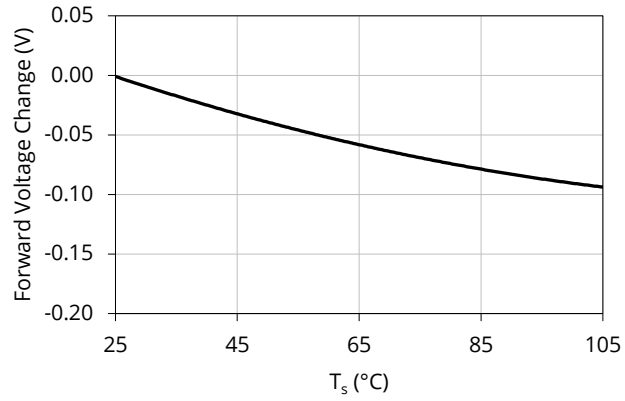

Vs. relative chromaticity shift

(5600K,  $I_F = 150\text{mA}$ )

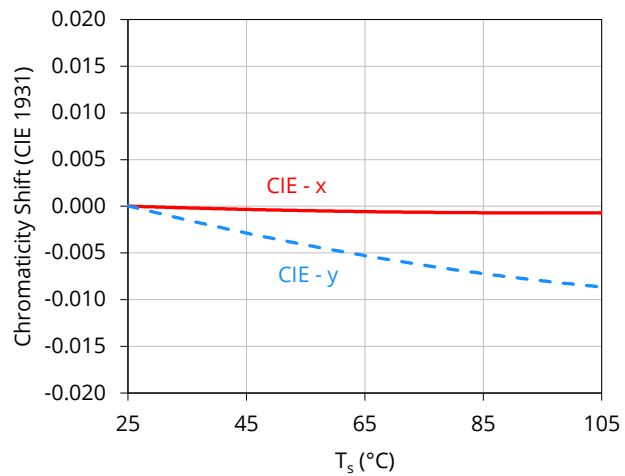

Vs. absolute chromaticity shift

(5600K,  $I_F = 150\text{mA}$ )

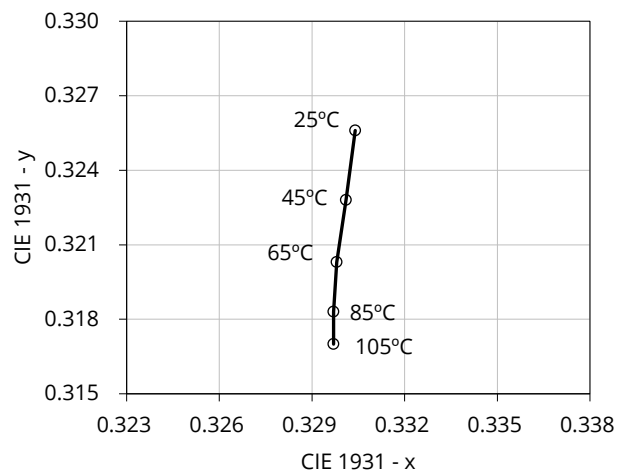

## Characteristic graph

Spatial distribution ( $T_A = 25^\circ\text{C}$ ,  $I_F = 150\text{mA}$ )

All characteristic curves are for reference only and not guaranteed.

**White**

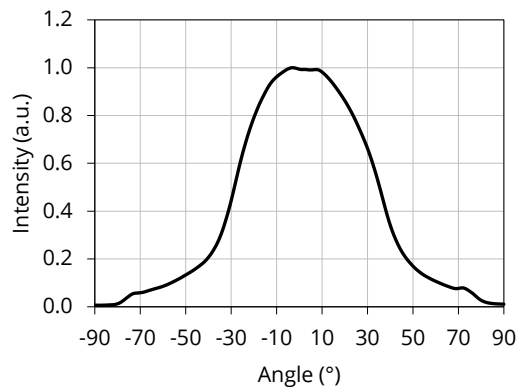

**Red**

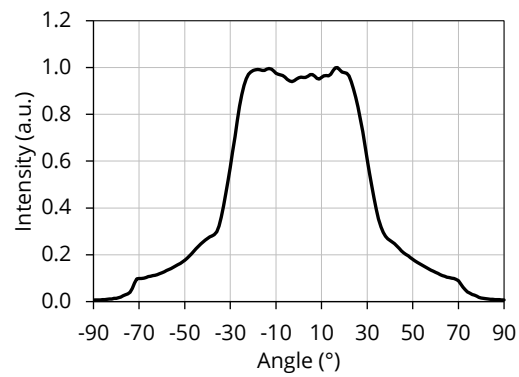

## Characteristic graph

Spatial distribution ( $T_A = 25^\circ\text{C}$ ,  $I_F = 150\text{mA}$ ) (continued)

All characteristic curves are for reference only and not guaranteed.

**Green**

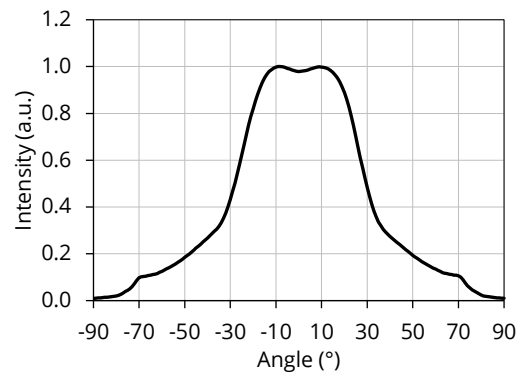

**Blue**

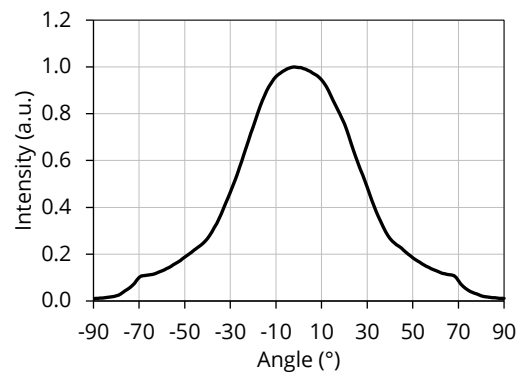

## Solder and reflow profile

### Recommended solder pad layout

All dimensions in mm, tolerance unless mentioned is  $\pm 0.1$ mm.

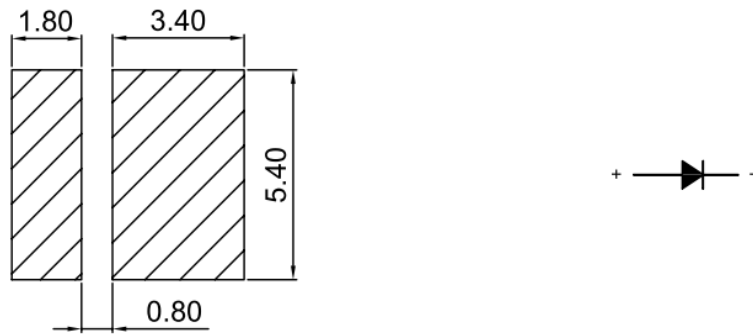

### Reflow profile

Soldering ramp-up time (Pb-FREE).

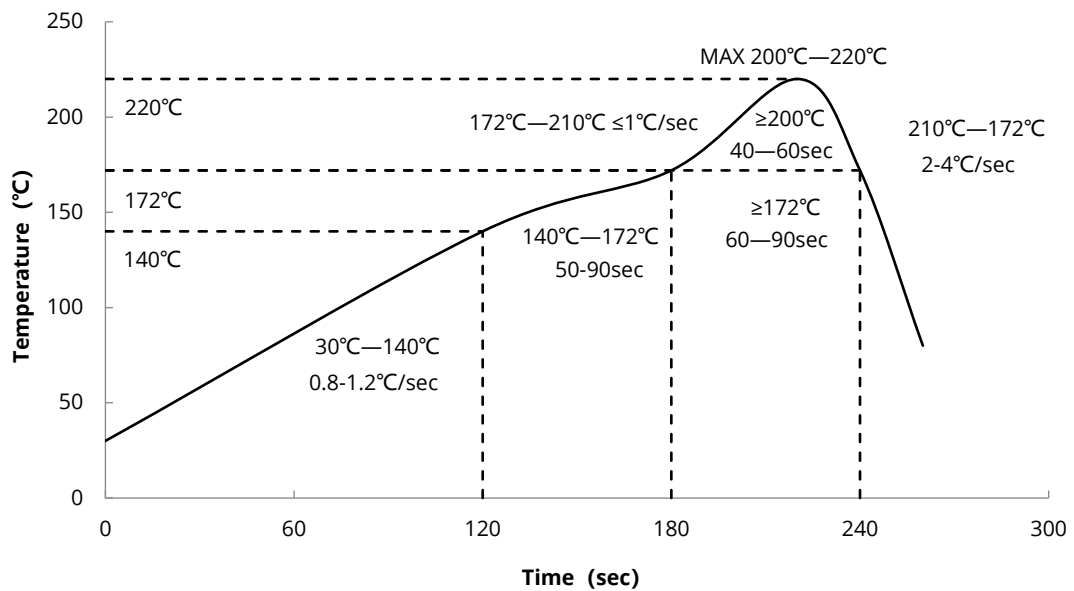

Note: Soldering paste with the melting point at 170°C is recommended.

---

## SMT instruction

### Problems caused by improper selection of collet

Choosing the right collet is important in ensuring product quality after SMT. LEDs are different from other electronic components, as they are not only concerned with electrical output but also optical output. This characteristic makes LEDs more fragile in the process of SMT. If the collet's lowering height is not well set, it will bring damage to the gold wire at the time of collet's pick-and-place process which can cause the LED to not illuminate, flicker or contribute to other quality problems, some of which may not be immediately detectable.

### Collet selection

During SMT, please choose the appropriate collet in order to avoid damage the gold wire inside the LED or insufficient suction. Setting the height of the collet is crucial in order to avoid damage to the top view SMD. If the collet setting is set to too low of an altitude, the collet will press down on the SMD, causing damage or breakage to the encapsulant and cause distortion or breakage of the gold wire.

### Other notes of caution

- No pressure should be exerted to the epoxy shell of the SMD under high temperature.
- Do not scratch or wipe the lens since the lens and gold wire inside are rather fragile and cross out easy to break.
- LED should be used as soon as possible when being taken out of the original package, and should be stored in anti-moisture and anti-ESD package.
- This usage and handling instructions are for reference only.

## Tape and reel specifications

Tape dimensions (unit: mm)

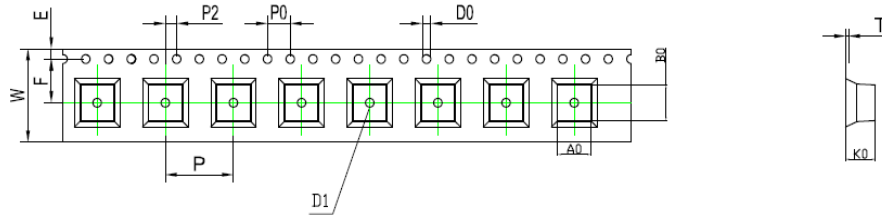

Symbol	A0	B0	K0	P0	P	P2	Length / Reel
Spec	5.80 ±	6.10 ±	4.90 ±	4.00 ±	12.0 ±	2.00 ±	4000
	0.10	0.10	0.10	0.10	0.10	0.10	
Symbol	W	T	E	F	D0	D1	-
Spec	16.0 ±	0.40 ±	1.75 ±	7.50 ±	1.50 ±	1.50 ±	-
	0.30	0.05	0.10	0.10	0.10	0.10	

## Tape layout

Not drawn to scale.

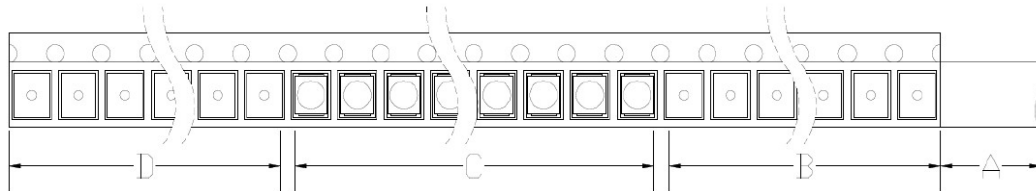

- A: Cover tape, 300mm;
- B: Empty leader, 600mm;
- C: LED, 1000pcs;
- D: Empty trailer, 600mm.

## Tape and reel specifications

Reel dimensions top (unit: mm)

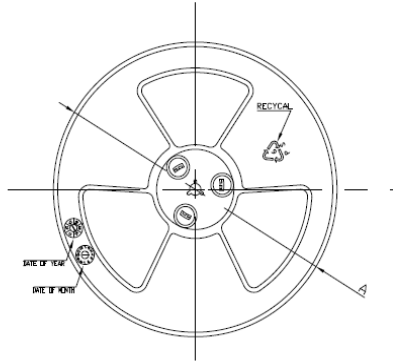

Reel dimensions side (unit: mm)

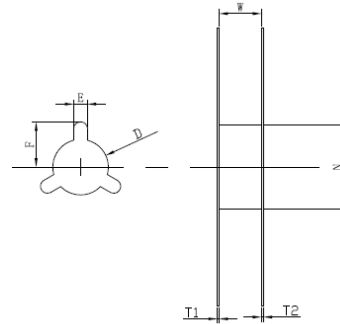

Feeding direction

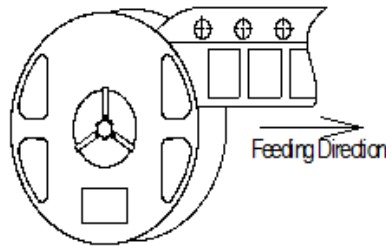

Spec	12	16	24	32	44	56	72
<b>E ± 0.5</b>	2.3	2.3	2.3	2.3	2.3	2.3	2.3
<b>F ± 0.5</b>	10.75	10.75	10.75	10.75	10.75	10.75	10.75
<b>W ± 0.2</b>	12.4	16.4	24.5	32.4	44.4	56.4	72.4
<b>T1 ± 0.3</b>	2.2	2.2	2.2	2.2	2.2	2.2	2.2
<b>T2 ± 0.3</b>	2.2	2.2	2.2	2.2	2.2	2.2	2.2
<b>A ± 0.2</b>	Ø330	Ø330	Ø330	Ø330	Ø330	Ø330	Ø330
<b>N ± 0.3</b>	Ø100	Ø100	Ø100	Ø100	Ø100	Ø100	Ø100
<b>D ± 0.3</b>	13.3	13.3	13.3	13.3	13.3	13.3	13.3



## Box packaging

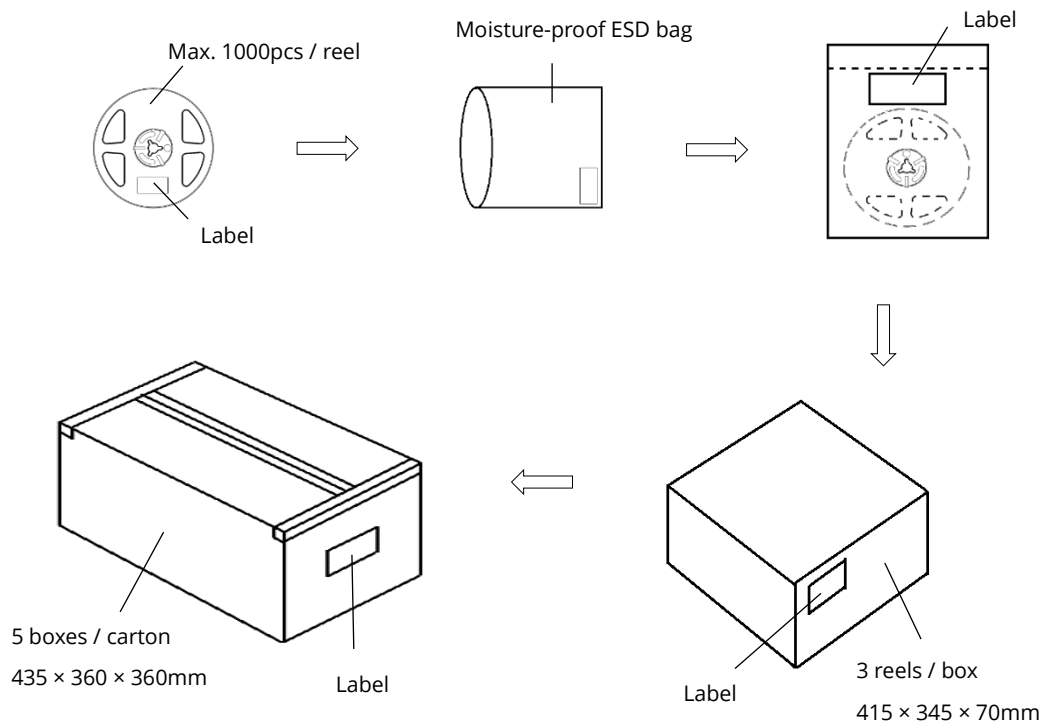

- Reeled products (max 1000 pcs / reel) are packed in a moisture-proof bag along with a moisture desiccant pack.
- Each inner box contains up to 3 moisture-proof bag (total maximum number of SMDs is 3000pcs). Box package size: 415 mm x 345 mm x 70 mm.
- Each outer package contains 5 inner boxes. Box size: 435 mm x 360 mm x 360 mm.
- Outer package is sealed with protective bubble wrap and foam. (Part numbers, lot numbers, quantity should appear on the label on the moisture-proof bag, part numbers).
- This packaging merely intended as a reference for standard quantity orders only – please note that actual packaging can differ depending on the order circumstances.

## About Yujileds



**Our story** - Start from the superior stable red LED phosphor.

We started to make LED phosphor materials in 2006. White LEDs were still in very early stage, the industry focused on improving device brightness and efficiency via yellow phosphor very much. No one cared about the light quality. Based on this situation, we took a different approach and focused on red phosphor technology, which is the most important phosphor recipe for high CRI and/or low CCT LEDs, and it made Yuji become a JV partner with Mitsubishi Chemical from 2012.

Today, we are well known for our comprehensive research and full line-up production of LED phosphor from ultra-violet to near-infrared, and we are proud to commit to providing superior stable and efficient phosphors to the worldwide markets.

**Our technology** - Focus on LED spectrum innovation.

The industrial structure of both phosphor and LED gives us a unique view to develop our spectrum recipes. Compared to the general LED manufacturers, we have comprehensive information in evaluating the feasibility for both technical and commercial aspects. LED spectrum technology is not only about the quality of white LEDs, but also for different applications which have specialized requirements in lighting.

Yuji is one of the few companies that provide the service of designing or customizing a specific spectrum for clients, our confidence comes from the years of accumulation in focusing on the spectrum technologies and the control of LED phosphor and LED die supply-chain with thousands of successful cases in the past years. Innovating LED technologies and giving them commercial values are our eternal driving forces.

**Our product** - Yujileds®, stands for high-performance LED.

The trademark of Yujileds® is the identification of the LED products developed and manufactured by Yuji. We put our understanding of the LED technologies and the standard of our quality control into every LED we make. Regardless of any product series, we pay attention to expressing the high-performance feature and achieving the product value for clients and never compromise in pursuing the true performance.

Furthermore, we also care about every detail of any documentation we prepare for the product because we

---

understand the importance to transmit accurate information to clients. It is even more critical for clients to obtain the truth to decide the solution, rather than just a nominal high-performance.

**Our client** - Outstanding game players in different fields.

Clients are our proudest achievements, now over 200 of our clients are the best game players in their fields in more than 33 countries. We regard the clients' successes as our biggest accomplishments and appreciate their contribution in different fields, clients use our LEDs not just for simple lighting, but to design the lighting for plants, cameras, sensors, health, circadian rhythm, animals, and other industries that we have never imagined that our technologies can be utilized, that makes our work so meaningful.

**Our service** - Professional supporting team.

There is a group of people in Yuji passionate about creating maximum value for our clients. We have accumulated experience in different projects. Currently, the company gathers more than 30 experts from various fields of semiconductor, chemistry, optics, photoelectricity, circuitry, materials and color science.

Our sales team is well trained in deep LED technologies and has skilled global communication experience. Not just for sales, our team is more like a specialized consultancy to help every client succeed in different projects, and we do not only provide professional business service, but also support in the supply chain, logistics, marketing and technical discussions.

**Contact us** - We look forward to providing our efficient service for you.

**LED website:** [www.yujiintl.com](http://www.yujiintl.com)

Find Yujileds® high-performance LEDs, read our insights into a variety of advanced technologies and applications.

Contact: [info@yujigroup.com](mailto:info@yujigroup.com)

**LED lighting website:** [www.yujilighting.com](http://www.yujilighting.com)

Find our state-of-art LED lamps and luminaires designed for improving the lighting experience with the vision of illuminating the future.

Contact: [lighting@yujigroup.com](mailto:lighting@yujigroup.com)

**Online shop:** [store.yujiintl.com](http://store.yujiintl.com)

Shop your favorite Yuji Lighting product with rapid and professional service.

Contact: [webstore@yujigroup.com](mailto:webstore@yujigroup.com)