



YJ-VTC-135XL-G01

Chip-on-board LED



Applications

- High-end architectural lighting
- Photographic/broadcast lighting
- Photoelectric device and relevant research

Features

- Full spectrum
- Industrial high CRI performance
- 5W power consumption
- 13.5 mm × 13.5 mm chip-on-board LED
- TLCI & TM-30 specified

[About Yujileds[®]](#)

Rev Version: 2.0

P31150007.00

Table of Contents

General description	3
Ordering information	8
Characteristics	9
Electrical-optical characteristics ($T_A = 25^\circ\text{C}$, 240mA)	9
Absolute maximum ratings ($T_A = 25^\circ\text{C}$)	10
Chromaticity group and diagram	11
Chromaticity bins & coordinates	11
CIE 1931 diagram.....	11
Dimension	12
Characteristic graph	13
Typical spectral power distribution (normalized).....	13
Forward current.....	14
Vs. forward voltage.....	14
Vs. relative luminous flux.....	14
Derating based on case point	14
Spatial distribution ($T_A = 25^\circ\text{C}$, $I_F = 240\text{mA}$).....	15
About Yujileds	16

General description

The sun is well recognized as the perfect light source because of its completely uniform, continuous and broad spectrum. With the development of artificial lighting technologies, efficiency is improved significantly however the illumination quality gets worse. There is no longer a light source that is like incandescent or halogen with perfect spectrum, especially when LED is invented and widely applied, while achieving unprecedented energy saving benefits, we have sacrificed the illumination quality tremendously until the Yujileds® VTC series LEDs come out.

95% spectral similarity to the sunlight

The wavelength range for human visual sensitivity is generally considered as 400nm – 700nm, for which the sun spectrum covers completely. On account of the illumination principle, a standard LED only covers 430nm – 670nm with at least 20% relative radiant power compared to the 450nm peak wavelength, therefore the purple and deep red light are missed in a standard LED, furthermore the sharp peak of the blue light has been an intractable challenge for many years.

Yujileds VTC technology succeeds in broadening the spectrum coverage to 400nm – 730nm, which is 40% more coverage than a standard LED spectrum, in addition, the VTC technology eliminates the sharp blue peaks then achieves the homogeneous spectral power distribution hence it mimics 95% similarity to the sunlight within the visible spectrum.

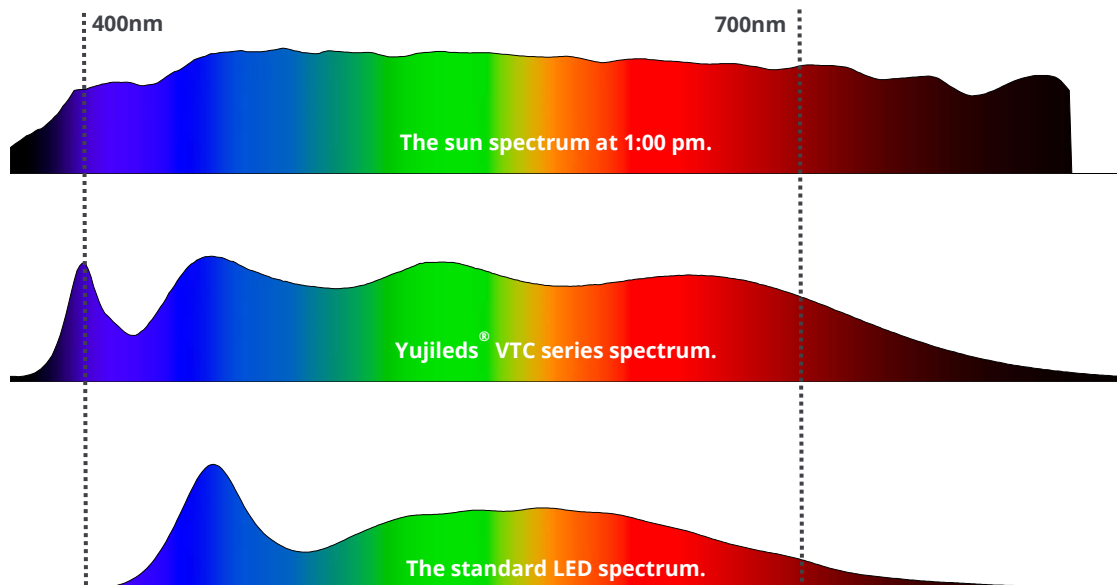

No compromise on the spectral quality

Not limited to a fixed full spectrum, the VTC technology can extend to wider CCT scopes. The spectral recipe of each CCT is well designed with Yujileds state-of-the-art LED phosphor and the well-chosen LED dies. By covering the practical solar spectra at any time all day, the illumination quality will never be compromised regardless of any CCT is selected. Eventually we can obtain a better light source than incandescent and halogen based on LED with the full flexibility of different white lights thanks to the VTC technology.

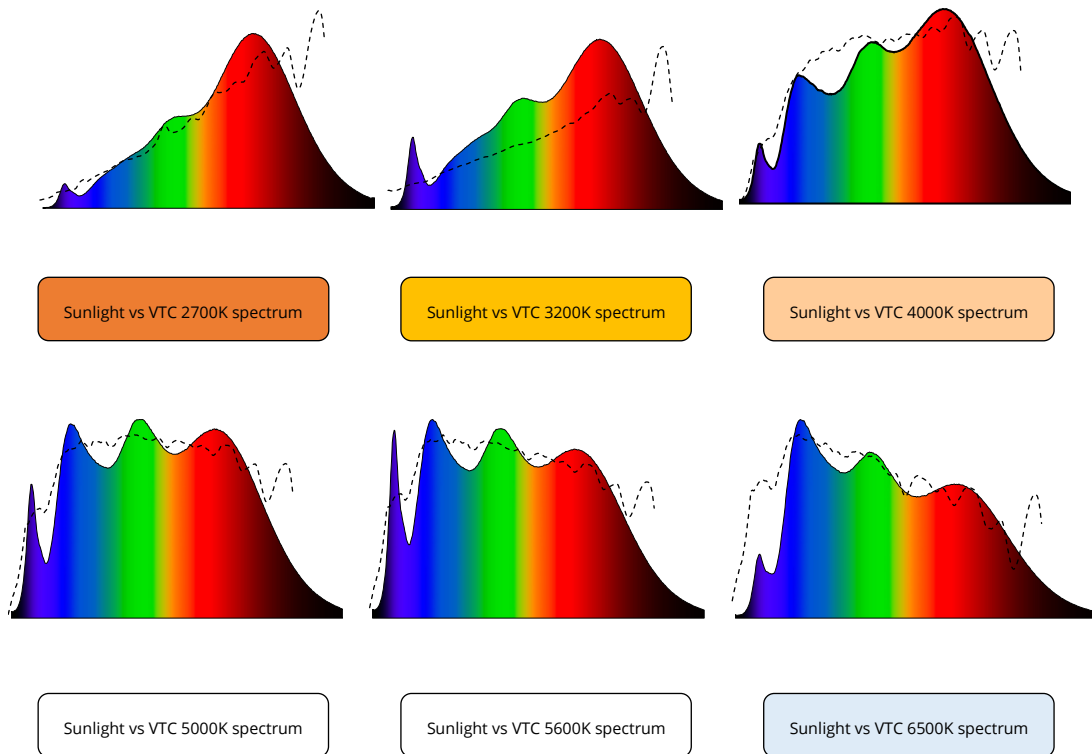

98 CRI for true color vividness

CRI (Color Rendering Index) is a most accepted colorimetric for evaluating the ability of a light source rendering the original color of an object. Benefiting from the full spectrum, the VTC series LED performs remarkable color rendition by achieving the CRI up to 98 (with minimum 95) where the full-score is 100. Comparatively, a standard 80 CRI LED which is still widely used performs less color fidelity and saturation.

Introduce the TM-30 metric for 99 color evaluation samples

The TM-30 metric is defined and proposed by the Illuminating Engineering Society (IES), aiming to provide comprehensive evaluation on color quality of new light sources especially for LED and it is released as the supplement or even replacement of CRI in the future. TM-30 utilizes 99 color evaluation samples which are selected from more than 100000 measured objects to be representative of the world of possible colors. Compared to CRI, the TM-30 is more critical on the spectral quality therefore when a standard LED has a CRI as 97, the Rf (Fidelity Index) of TM-30 is about 90, but for VTC series 99 CRI LED,

the Rf is maintained as 95-97 which means the VTC technology provides extremely stable ability for rendering most of the possible colors.

Constant color rendition

Colors are not only well rendered under one specific spectrum but for all CCTs covering from the warm white to daylight. As the result of the well-designed spectral recipes, CRI values are ensured to be constant and since the VTC technology focuses on the spectral quality, likewise the TM-30 scores are maintained at high values constantly.

2700K

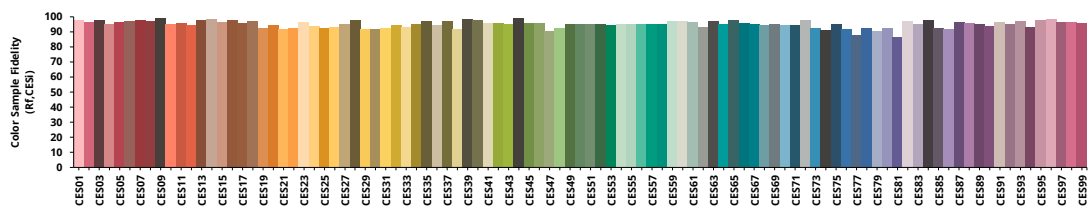
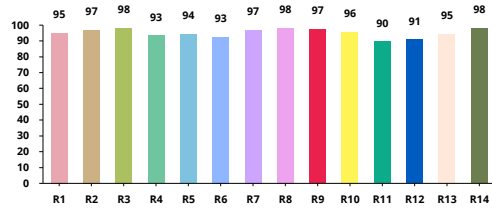

3200K

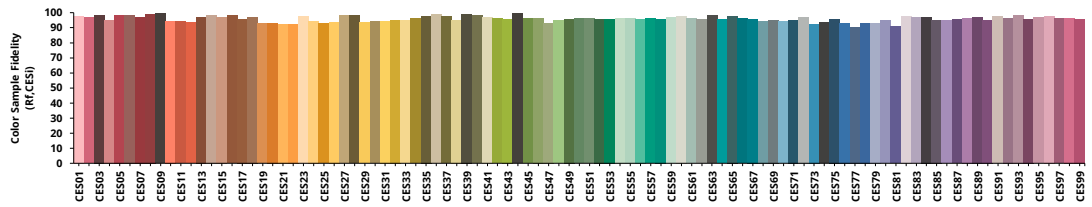
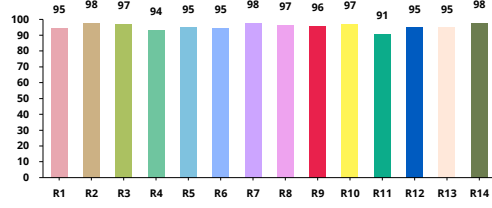

4000K

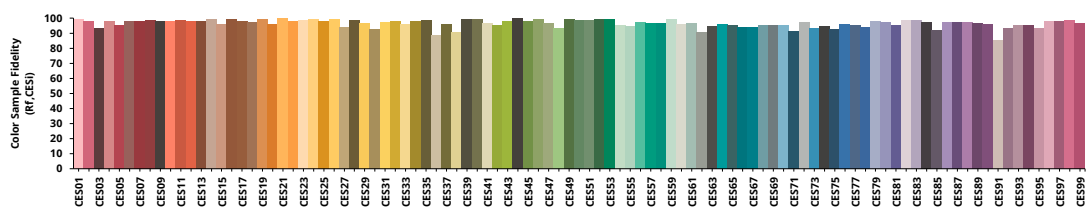
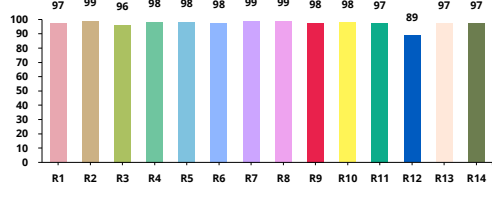

5000K

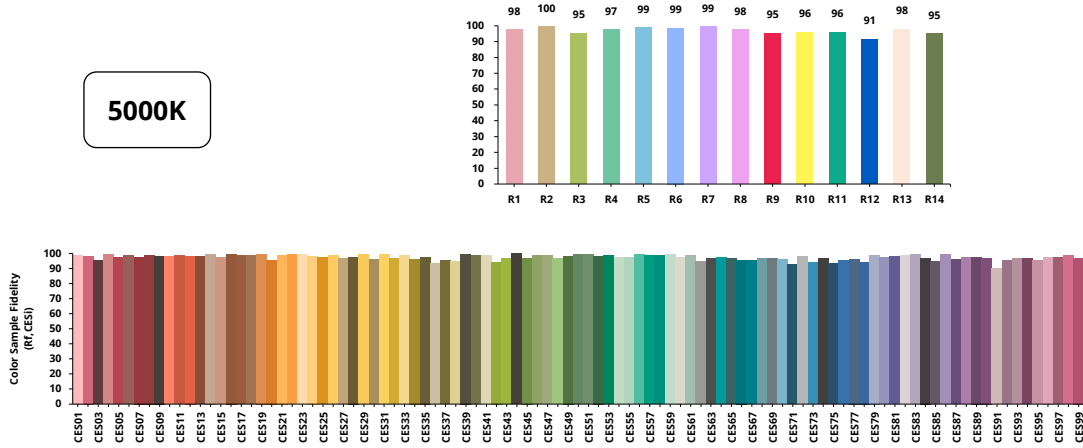

5600K

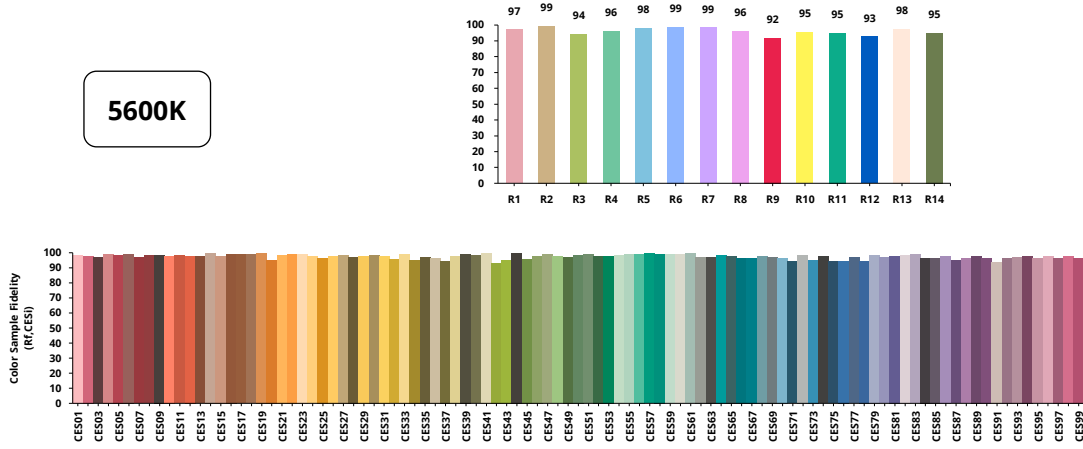

6500K

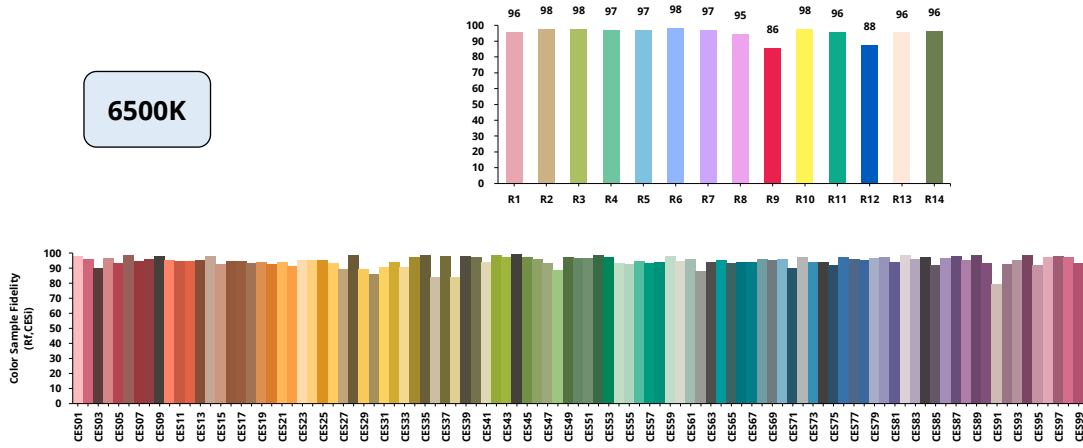

The VTC series 135XL LED also supports the unique service/certification by Yujileds® as described below.



TM-30-18 specification

The most advanced colorimetric for color rendition, widely recognized as the successor of CRI.



TLCI
Specified

TLCI specification

Based on the Macbeth ColorChecker, for evaluating the colorimetric quality of the broadcast lighting.



**Simple
Binning**

SimpleBinning specification

Simplify the chromaticity binning with TrueChroma data support to provide the most economical, simple, and practical solution to customers.



REACH
Compliance

REACH compliance (Phosphor)

Ordering information

PART NUMBER	PRODUCT CODE	CCT	CHROMATICITY BINS
YJ-VTC-135XL-G01-27	P3150007.27	2700K	V27L, V27R
YJ-VTC-135XL-G01-32	P3150007.32	3200K	V32L, V32R
YJ-VTC-135XL-G01-56	P3150007.56	5600K	V56L, V56R
YJ-VTC-135XL-G01-65	P3150007.65	6500K	V65L, V65R
YJ-VTC-135XL-G01-XX	P3150007.XX	Custom CCT	-

Characteristics

Electrical-optical characteristics ($T_A = 25^\circ\text{C}$, 240mA)

PARAMETER	SYMBOL	VALUE			UNIT	TOLERANCE
		MIN.	TYP.	MAX.		
Forward voltage	V_F	16	-	24	V	± 0.05
Luminous flux	Φ_{2700K}	120	-	220	lm	-
	Φ_{3200K}	145	-	250		
	Φ_{5600K}	250	-	425		
	Φ_{6500K}	250	-	425		
Correlated color temperature⁽¹⁾	CCT_{2700K}	2550	2700	2850	K	-
	CCT_{3200K}	3050	3200	3350		
	CCT_{5600K}	5300	5600	5900		
	CCT_{6500K}	6000	6500	7000		
Color rendering index	R_a	95	-	-	-	± 1
TCS R9 (CRI red)	R_9	-	90	-	-	-
Fidelity index⁽²⁾	R_f	-	97	-	-	-
Gamut index⁽²⁾	R_g	-	100	-	-	-
TLCI 2012⁽³⁾	-	-	99	-	-	-
Reverse current	I_r	-	-	20	μA	$\pm 0.1 (V_r = 5V)$
View angle	$2\theta_{1/2}$	-	120	-	Deg	± 5

(1). Yujileds® promises the chromaticity coordinate tolerance of ± 0.0015 (CIE 1931 x,y) based on Yuji standard equipment shall prevail.

(2). Defined by the IES TM-30-18 method, this data is for trial.

(3). Defined by the EBU, TLCI is the abbreviation of Television Lighting Consistency Index, this data is for trial.

Absolute maximum ratings ($T_A = 25^\circ\text{C}$)

PARAMETER	SYMBOL	LIMIT	UNIT
Power Consumption	P_D	6000	mW
DC Forward Current (pulsed)⁽¹⁾	I_{FP}	300 ⁽²⁾	mA
DC Forward Current	I_F	250	mA
Reverse Voltage	V_R	30	V
Junction Temperature	T_j	125	$^\circ\text{C}$
Case Temperature⁽³⁾	T_s	85	$^\circ\text{C}$
Operating Temperature	T_{opr}	-20 ~ +75	$^\circ\text{C}$
Storage Temperature	T_{stg}	-30 ~ +80	$^\circ\text{C}$
Soldering Temperature	T_{sol}	260 \pm 5	$^\circ\text{C}$
Reflow Cycles Allowed	-	2	-

(1). Pulse width $\leq 0.1\text{ms}$, duty $\leq 1/10$.

(2). Theoretical data.

(3). See page [Dimension](#).

Chromaticity group and diagram

Chromaticity bins & coordinates

CCT	BIN	CIE 1931 COORDINATES							
		X0	Y0	X1	Y1	X2	Y2	X3	Y3
2700K	V27L	0.4525	0.4160	0.4440	0.4000	0.4552	0.4025	0.4642	0.4185
	V27R	0.4642	0.4185	0.4552	0.4025	0.4672	0.4048	0.4775	0.4215
3200K	V32L	0.4187	0.4065	0.4125	0.3906	0.4213	0.3940	0.4284	0.4103
	V32R	0.4284	0.4103	0.4213	0.3940	0.4309	0.3972	0.4389	0.4143
5600K	V56L	0.3232	0.3470	0.3239	0.3338	0.3301	0.3389	0.3298	0.3529
	V56R	0.3298	0.3529	0.3301	0.3389	0.3371	0.3447	0.3376	0.3595
6500K	V65L	0.3045	0.3261	0.3069	0.3141	0.3139	0.3212	0.3123	0.3335
	V65R	0.3123	0.3335	0.3139	0.3212	0.3222	0.3293	0.3214	0.3413

CIE 1931 diagram

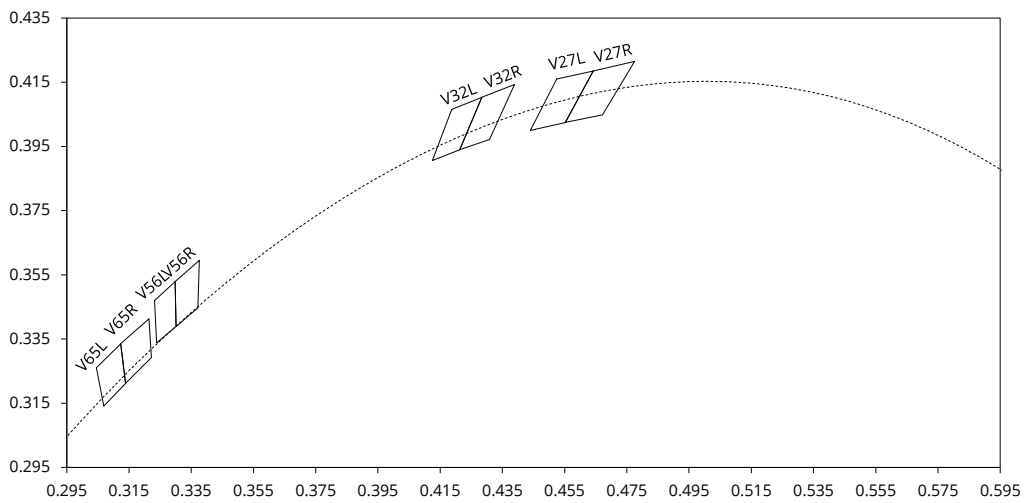

Dimension

All dimensions in mm, tolerance unless mentioned is ± 0.1 mm.

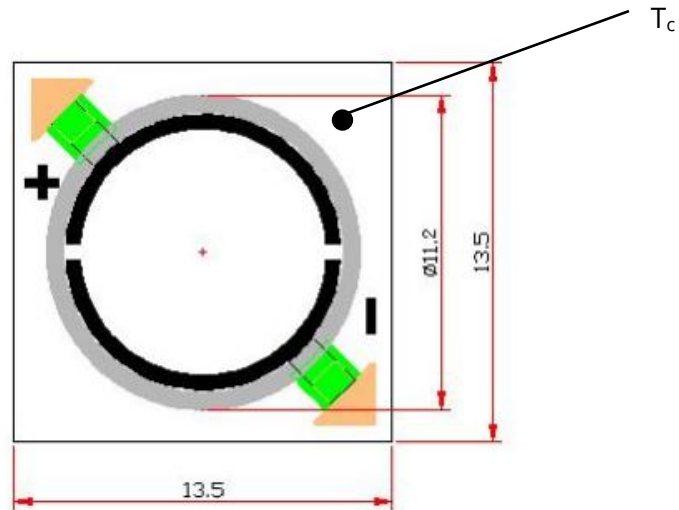

Characteristic graph

Typical spectral power distribution (normalized)

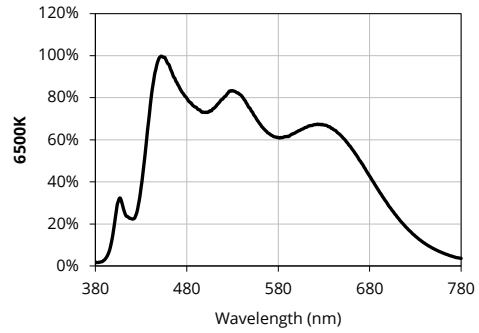
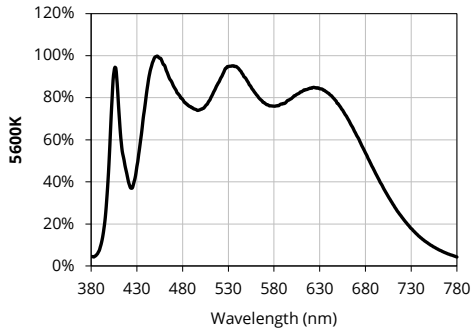
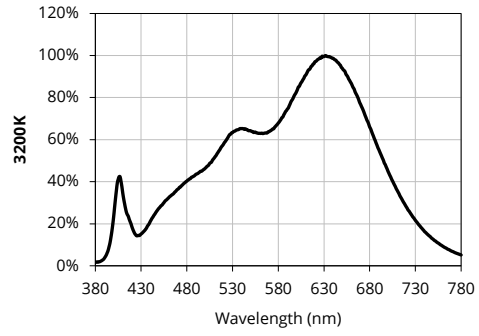
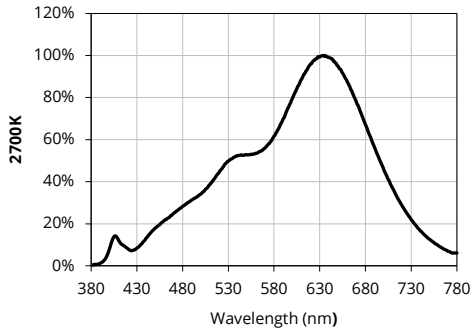

Characteristic graph

Forward current

All characteristic curves are for reference only and not guaranteed.

Vs. forward voltage

($T_A = 25^\circ\text{C}$)

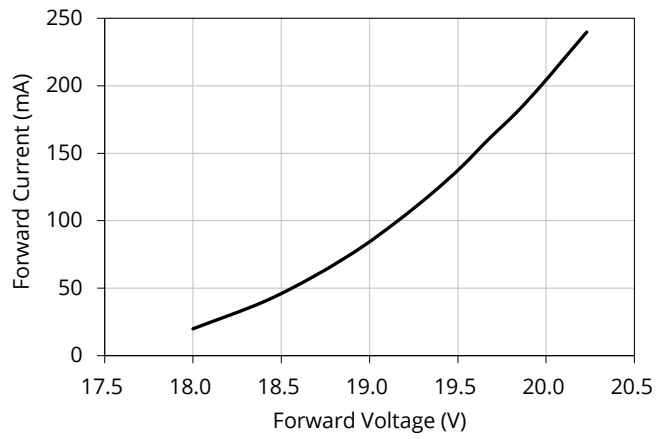

Vs. relative luminous flux

($T_A = 25^\circ\text{C}$)

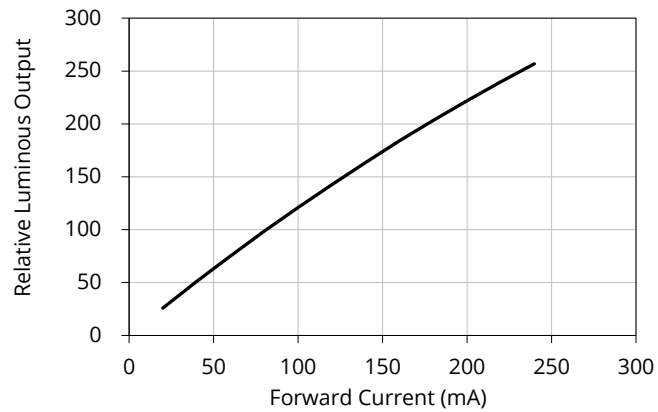

Derating based on case point

Note: De-rating curves are meant for recommendation only and are not meant to provide guarantees of product stability and longevity.

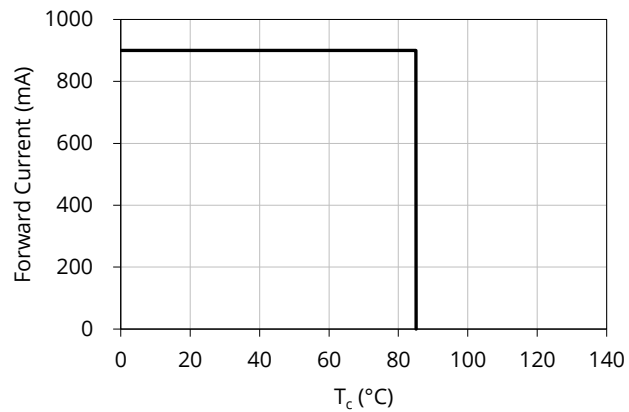

Characteristic graph

Spatial distribution ($T_A = 25^\circ\text{C}$, $I_F = 240\text{mA}$)

All characteristic curves are for reference only and not guaranteed.

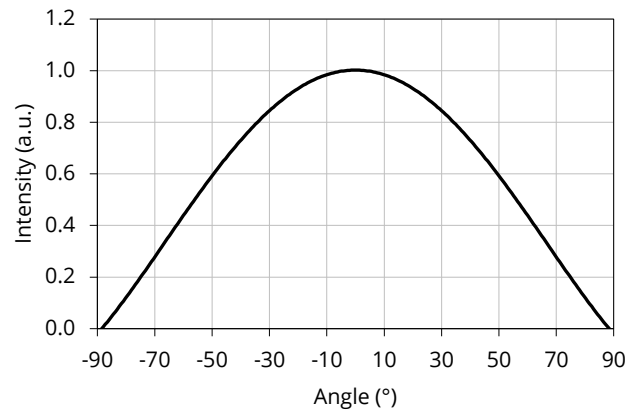

About Yujileds



Our story - Start from the superior stable red LED phosphor.

We started to make LED phosphor materials in 2006. White LEDs were still in very early stage, the industry focused on improving device brightness and efficiency via yellow phosphor very much. No one cared about the light quality. Based on this situation, we took a different approach and focused on red phosphor technology, which is the most important phosphor recipe for high CRI and/or low CCT LEDs, and it made Yuji become a JV partner with Mitsubishi Chemical from 2012.

Today, we are well known for our comprehensive research and full line-up production of LED phosphor from ultra-violet to near-infrared, and we are proud to commit to providing superior stable and efficient phosphors to the worldwide markets.

Our technology - Focus on LED spectrum innovation.

The industrial structure of both phosphor and LED gives us a unique view to develop our spectrum recipes. Compared to the general LED manufacturers, we have comprehensive information in evaluating the feasibility for both technical and commercial aspects. LED spectrum technology is not only about the quality of white LEDs, but also for different applications which have specialized requirements in lighting.

Yuji is one of the few companies that provide the service of designing or customizing a specific spectrum for clients, our confidence comes from the years of accumulation in focusing on the spectrum technologies and the control of LED phosphor and LED die supply-chain with thousands of successful cases in the past years. Innovating LED technologies and giving them commercial values are our eternal driving forces.

Our product - Yujileds®, stands for high-performance LED.

The trademark of Yujileds® is the identification of the LED products developed and manufactured by Yuji. We put our understanding of the LED technologies and the standard of our quality control into every LED we make. Regardless of any product series, we pay attention to expressing the high-performance feature and achieving the product value for clients and never compromise in pursuing the true performance.

Furthermore, we also care about every detail of any documentation we prepare for the product because we

understand the importance to transmit accurate information to clients. It is even more critical for clients to obtain the truth to decide the solution, rather than just a nominal high-performance.

Our client - Outstanding game players in different fields.

Clients are our proudest achievements, now over 200 of our clients are the best game players in their fields in more than 33 countries. We regard the clients' successes as our biggest accomplishments and appreciate their contribution in different fields, clients use our LEDs not just for simple lighting, but to design the lighting for plants, cameras, sensors, health, circadian rhythm, animals, and other industries that we have never imagined that our technologies can be utilized, that makes our work so meaningful.

Our service - Professional supporting team.

There is a group of people in Yuji passionate about creating maximum value for our clients. We have accumulated experience in different projects. Currently, the company gathers more than 30 experts from various fields of semiconductor, chemistry, optics, photoelectricity, circuitry, materials and color science.

Our sales team is well trained in deep LED technologies and has skilled global communication experience. Not just for sales, our team is more like a specialized consultancy to help every client succeed in different projects, and we do not only provide professional business service, but also support in the supply chain, logistics, marketing and technical discussions.

Contact us - We look forward to providing our efficient service for you.

LED website: www.yujiintl.com

Find Yujileds® high-performance LEDs, read our insights into a variety of advanced technologies and applications.

Contact: info@yujigroup.com

LED lighting website: www.yujilighting.com

Find our state-of-art LED lamps and luminaires designed for improving the lighting experience with the vision of illuminating the future.

Contact: lighting@yujigroup.com

Online shop: store.yujiintl.com

Shop your favorite Yuji Lighting product with rapid and professional service.

Contact: webstore@yujigroup.com