



# YJ-RGB5050H-G01

Surface Mount Device

## Applications

- High-end architectural lighting
- Photographic/broadcast lighting
- Photoelectric device and relevant research



## Features

- Multiple color solution
- Full-color gamut of red, green and blue
- 5.0 mm × 5.5mm package

[About Yujileads<sup>®</sup>](#)

Rev Version: 2.0

P3180002.00

---

## Table of Contents

General description .....	3
Ordering information .....	4
Characteristics .....	5
Package material and dimension.....	7
Characteristic graph .....	8
Solder and reflow profile .....	11
SMT instruction .....	12
About Yujileds .....	13

## General description

YUJILEDS® Multichromatic series 5050 3-in-1 LED combines red, green and blue dies in one package. The compact package and high output make the LED suitable for a wide variety of applications demanding higher color quality distribution, and it also simplify the optical design.

The Multichromatic series 5050 LED also supports the unique service/certification by Yujileds® as described below.



**RoHS 2011/65/EU compliance**

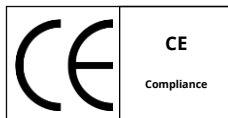

**CE compliance**



**REACH compliance (Phosphor)**

---

## Ordering information

PART NUMBER	PRODUCT CODE	COLOR
YJ-RGB5050H-G01	P3180002.00	R, G, B

## Characteristics

Electrical-optical characteristics ( $T_A = 25^\circ\text{C}$ , 60mA)

COLOR	PARAMETER	SYMBOL	VALUE			UNIT
			MIN.	TYP.	MAX.	
Red	Forward voltage	$V_F$	1.9	-	2.4	V
	Radiant power	$\Phi_e$	41	-	47	mW
	Dominant wavelength	$\lambda$	615	-	630	nm
	View angle	$2\theta_{1/2}$	-	120	-	Deg
Green	Forward voltage	$V_F$	2.7	-	3.5	V
	Radiant power	$\Phi_e$	29	-	36	mW
	Dominant wavelength	$\lambda$	515	-	530	nm
	View angle	$2\theta_{1/2}$	-	120	-	Deg
Blue	Forward voltage	$V_F$	2.8	-	3.5	V
	Radiant power	$\Phi_e$	67	-	77	mW
	Dominant wavelength	$\lambda$	450	-	465	nm
	View angle	$2\theta_{1/2}$	-	120	-	Deg

## Characteristics

Absolute maximum ratings ( $T_A = 25^\circ\text{C}$ )

PARAMETER	SYMBOL	RED	GREEN	BLUE	UNIT
<b>Power Consumption (Simultaneous)</b>	$P_D$		630		mW
<b>DC Forward Current (individual)</b>	$I_F$	70	80	120	mA
<b>DC Forward Current (Simultaneous)</b>	$I_F$	60	60	60	mA
<b>Reverse Voltage</b>	$V_R$		5		V
<b>Solder Point Temperature<sup>(1)</sup></b>			85		$^\circ\text{C}$
<b>Operating Temperature</b>	$T_{opr}$		-25 ~ +85		$^\circ\text{C}$
<b>Storage Temperature</b>	$T_{stg}$		-35 ~ +85		$^\circ\text{C}$
<b>Soldering Temperature</b>	$T_{sol}$		260 $\pm$ 5		$^\circ\text{C}$
<b>Reflow Cycles Allowed</b>	-		3		-

(1). See page [Package material and dimension](#).

## Package material and dimension

### Package layout

All dimensions in mm, tolerance unless mentioned is  $\pm 0.1\text{mm}$ .

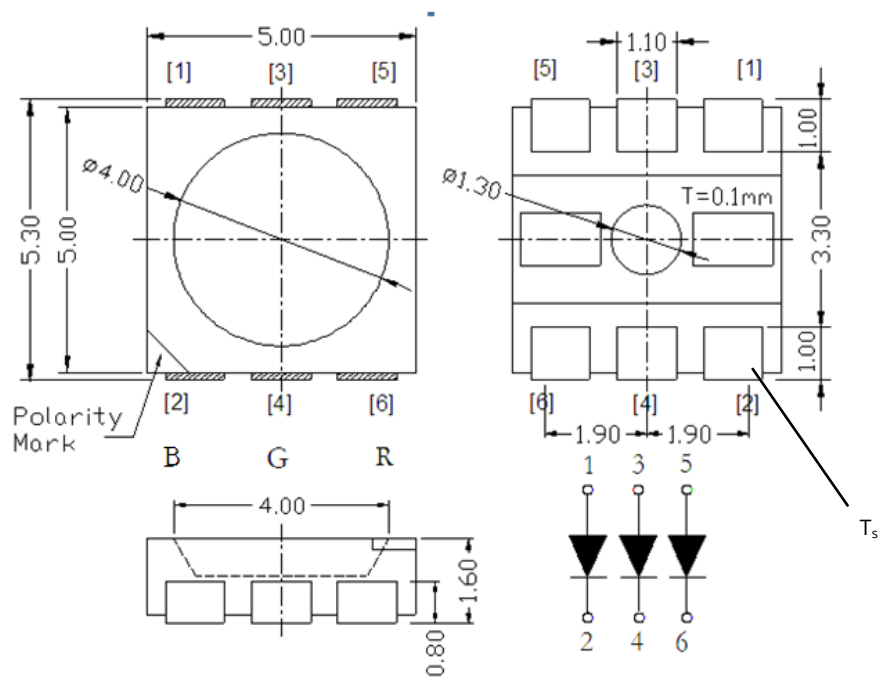

## Characteristic graph

Typical spectral power distribution ( $T_A = 25^\circ\text{C}$ ) (normalized)

All characteristic curves are for reference only and not guaranteed.

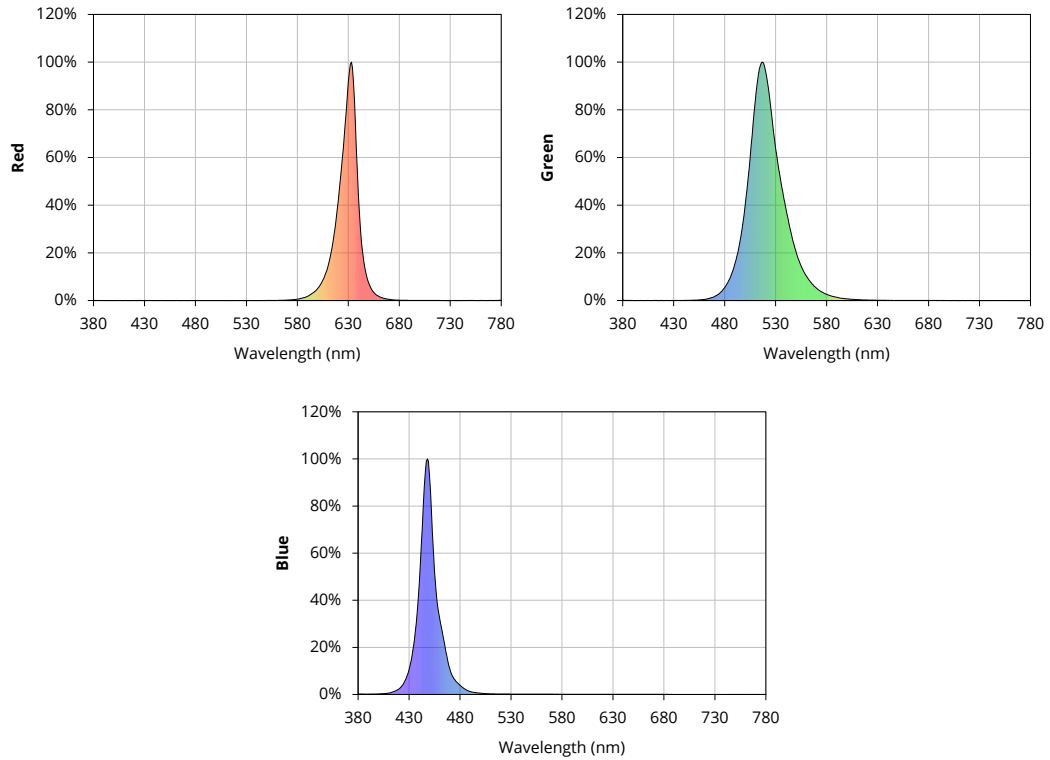



## Characteristic graph

### Forward current

All characteristic curves are for reference only and not guaranteed.

Vs. forward voltage

( $T_A = 25^\circ\text{C}$ )

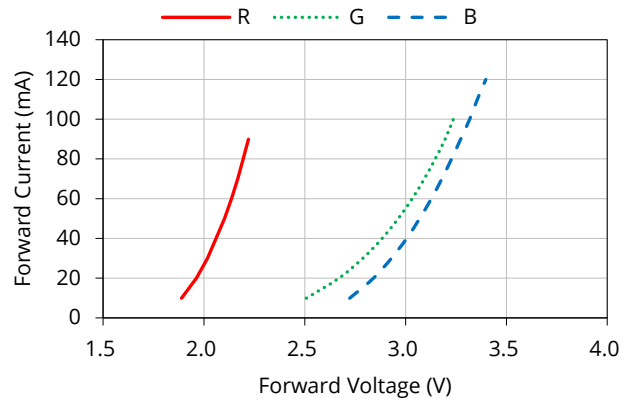

Vs. relative radiant flux /

luminous flux

( $T_A = 25^\circ\text{C}$ )

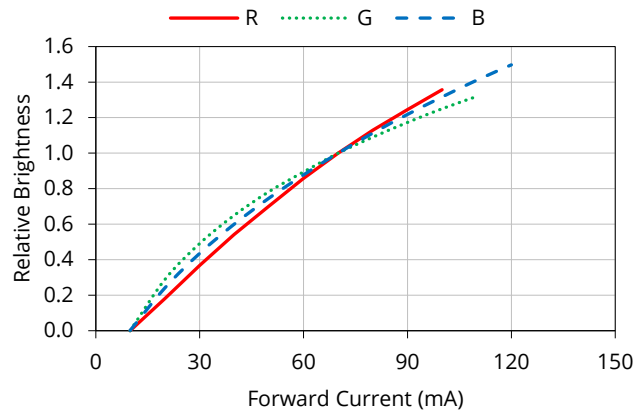

## Characteristic graph

### Forward current (continued)

All characteristic curves are for reference only and not guaranteed.

Vs. relative dominant  
wavelength shift / chromaticity  
shift  
( $T_A = 25^\circ\text{C}$ )

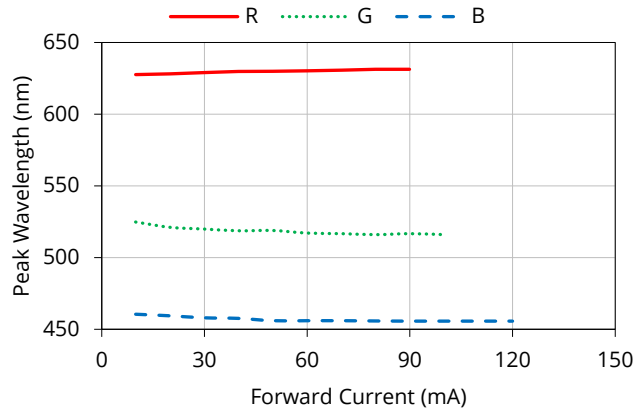

### Derating based on solder point

Note: De-rating curves are meant for  
recommendation only and are not meant  
to provide guarantees of product stability  
and longevity.

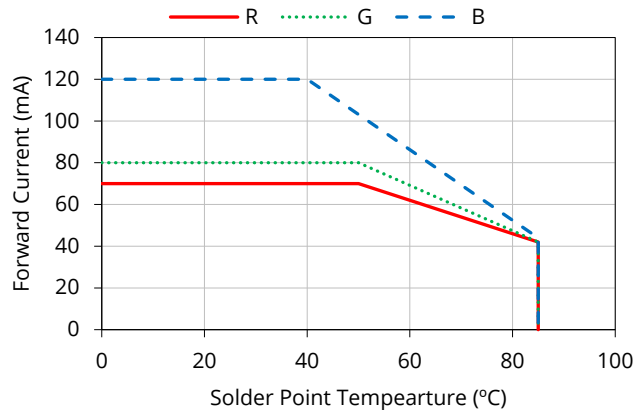

## Solder and reflow profile

### Recommended solder pad layout

All dimensions in mm, tolerance unless mentioned is  $\pm 0.1$ mm.

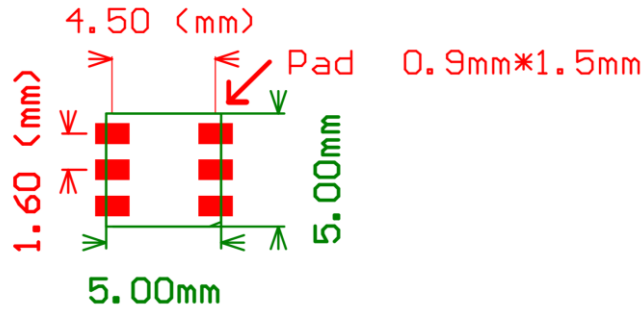

### Reflow profile

Soldering ramp-up time (Pb-FREE).

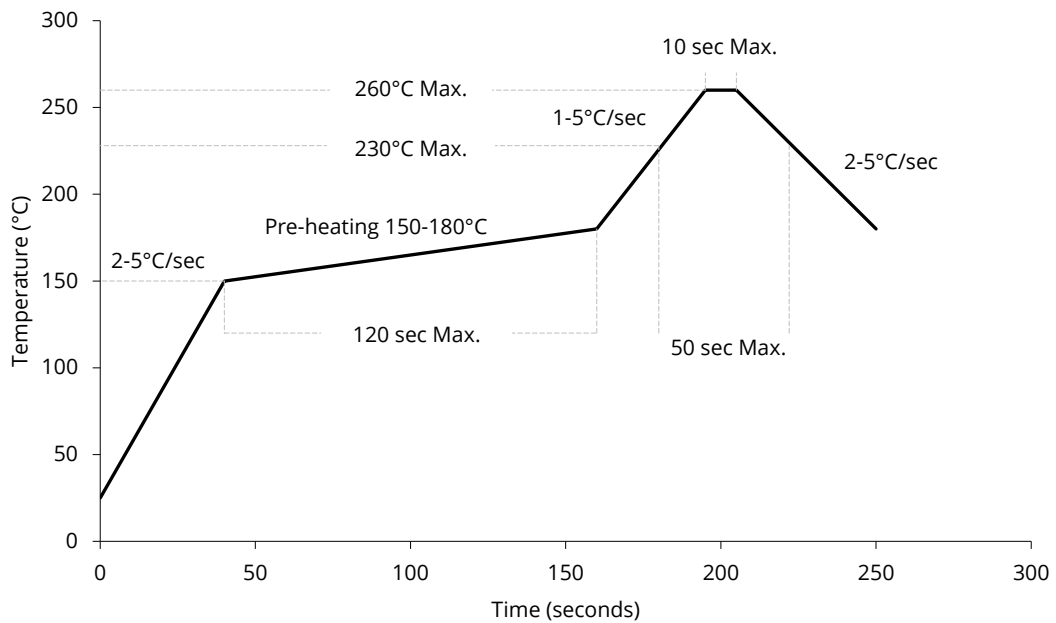

Note: Soldering paste with the melting point at 230°C is recommended.

---

## SMT instruction

### Problems caused by improper selection of collet

Choosing the right collet is important in ensuring product quality after SMT. LEDs are different from other electronic components, as they are not only concerned with electrical output but also optical output. This characteristic makes LEDs more fragile in the process of SMT. If the collet's lowering height is not well set, it will bring damage to the gold wire at the time of collet's pick-and-place process which can cause the LED to not illuminate, flicker or contribute to other quality problems, some of which may not be immediately detectable.

### Collet selection

During SMT, please choose the appropriate collet in order to avoid damage the gold wire inside the LED or insufficient suction. Setting the height of the collet is crucial in order to avoid damage to the top view SMD. If the collet setting is set to too low of an altitude, the collet will press down on the SMD, causing damage or breakage to the encapsulant and cause distortion or breakage of the gold wire.

### Other notes of caution

- No pressure should be exerted to the epoxy shell of the SMD under high temperature.
- Do not scratch or wipe the lens since the lens and gold wire inside are rather fragile and cross out easy to break.
- LED should be used as soon as possible when being taken out of the original package, and should be stored in anti-moisture and anti-ESD package.
- This usage and handling instructions are for reference only.

## About Yujileds



**Our story** - Start from the superior stable red LED phosphor.

We started to make LED phosphor materials in 2006. White LEDs were still in very early stage, the industry focused on improving device brightness and efficiency via yellow phosphor very much. No one cared about the light quality. Based on this situation, we took a different approach and focused on red phosphor technology, which is the most important phosphor recipe for high CRI and/or low CCT LEDs, and it made Yuji become a JV partner with Mitsubishi Chemical from 2012.

Today, we are well known for our comprehensive research and full line-up production of LED phosphor from ultra-violet to near-infrared, and we are proud to commit to providing superior stable and efficient phosphors to the worldwide markets.

**Our technology** - Focus on LED spectrum innovation.

The industrial structure of both phosphor and LED gives us a unique view to develop our spectrum recipes. Compared to the general LED manufacturers, we have comprehensive information in evaluating the feasibility for both technical and commercial aspects. LED spectrum technology is not only about the quality of white LEDs, but also for different applications which have specialized requirements in lighting.

Yuji is one of the few companies that provide the service of designing or customizing a specific spectrum for clients, our confidence comes from the years of accumulation in focusing on the spectrum technologies and the control of LED phosphor and LED die supply-chain with thousands of successful cases in the past years. Innovating LED technologies and giving them commercial values are our eternal driving forces.

**Our product** - Yujileds®, stands for high-performance LED.

The trademark of Yujileds® is the identification of the LED products developed and manufactured by Yuji. We put our understanding of the LED technologies and the standard of our quality control into every LED we make. Regardless of any product series, we pay attention to expressing the high-performance feature and achieving the product value for clients and never compromise in pursuing the true performance.

Furthermore, we also care about every detail of any documentation we prepare for the product because we

---

understand the importance to transmit accurate information to clients. It is even more critical for clients to obtain the truth to decide the solution, rather than just a nominal high-performance.

**Our client** - Outstanding game players in different fields.

Clients are our proudest achievements, now over 200 of our clients are the best game players in their fields in more than 33 countries. We regard the clients' successes as our biggest accomplishments and appreciate their contribution in different fields, clients use our LEDs not just for simple lighting, but to design the lighting for plants, cameras, sensors, health, circadian rhythm, animals, and other industries that we have never imagined that our technologies can be utilized, that makes our work so meaningful.

**Our service** - Professional supporting team.

There is a group of people in Yuji passionate about creating maximum value for our clients. We have accumulated experience in different projects. Currently, the company gathers more than 30 experts from various fields of semiconductor, chemistry, optics, photoelectricity, circuitry, materials and color science.

Our sales team is well trained in deep LED technologies and has skilled global communication experience. Not just for sales, our team is more like a specialized consultancy to help every client succeed in different projects, and we do not only provide professional business service, but also support in the supply chain, logistics, marketing and technical discussions.

**Contact us** - We look forward to providing our efficient service for you.

**LED website:** [www.yujiintl.com](http://www.yujiintl.com)

Find Yujileds® high-performance LEDs, read our insights into a variety of advanced technologies and applications.

Contact: [info@yujigroup.com](mailto:info@yujigroup.com)

**LED lighting website:** [www.yujilighting.com](http://www.yujilighting.com)

Find our state-of-art LED lamps and luminaires designed for improving the lighting experience with the vision of illuminating the future.

Contact: [lighting@yujigroup.com](mailto:lighting@yujigroup.com)

**Online shop:** [store.yujiintl.com](http://store.yujiintl.com)

Shop your favorite Yuji Lighting product with rapid and professional service.

Contact: [webstore@yujigroup.com](mailto:webstore@yujigroup.com)