



# YJ-BC-RGBW5050-G02

Surface Mount Device

## Applications

- High-end architectural lighting
- Photographic/broadcast lighting
- Photoelectric device and relevant research

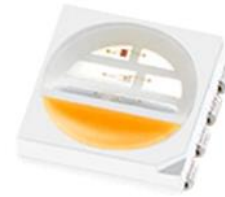

## Features

- Industrial highest CRI performance of white light
- Full-color gamut of red, green and blue
- 5.5mm × 5.0mm package
- TLCI & TM-30 specified (white light)
- SimpleBinning solution (white light)

## [About Yujileads<sup>®</sup>](#)

Document Number: YJWJ033

Rev Version: 2.1

P3180012.00

---

## Table of Contents

<b>General description .....</b>	<b>2</b>
<b>Ordering information .....</b>	<b>3</b>
<b>Characteristics .....</b>	<b>4</b>
Electrical-optical characteristics.....	4
Absolute maximum ratings .....	5
<b>Chromaticity group and diagram .....</b>	<b>6</b>
Chromaticity bins & coordinates .....	6
CIE 1931 diagram.....	6
<b>Package material and dimension.....</b>	<b>7</b>
Package layout.....	7
<b>Characteristic graph .....</b>	<b>8</b>
Typical spectral power distribution .....	8
Spatial distribution .....	9
<b>Reflow profile .....</b>	<b>10</b>
<b>SMT instruction .....</b>	<b>11</b>
Problems caused by improper selection of collet.....	11
Collet selection.....	11
Other notes of caution.....	11
<b>About YujileDS .....</b>	<b>12</b>

## General description

Yujileds® Multichromatic series RGBW5050 LED is an innovative low-power LED. It integrates four different color channels in a compact package. With Yujileds® advanced phosphors technology, the white light channel achieves industrial high CRI performance and consistency, and the color channels reach saturated and stable monochromatic. The compact package and high output make the LED suitable for a wide variety of applications demanding higher color quality and homogeneous lighting distribution, and it also simplify the optical design.

The Multichromatic series RGBW5050 LED also supports the unique service/certification by Yujileds® as described below.



### TM-30-18 specification

The most advanced colorimetric for color rendition, widely recognized as the successor of CRI.



### TLCI specification

Based on the Macbeth ColorChecker, for evaluating the colorimetric quality of the broadcast lighting.

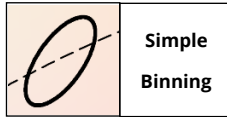

### SimpleBinning specification

Simplify the chromaticity binning with TrueChroma data support to provide the most economical, simple, and practical solution to customers.



### RoHS 2011/65/EU compliance



### REACH compliance (Phosphor)

## Ordering information

PART NUMBER	PRODUCT CODE	CCT	CHROMATICITY BINS	VOLTAGE RANGE
YJ-BC-RGBW5050-G02-32	P3180012.32	3200K	32N	0.2V for W 0.4V for R/G/B
YJ-BC-RGBW5050-G02-56	P3180012.56	5600K	56T	0.2V for W 0.4V for R/G/B

## Characteristics

Electrical-optical characteristics ( $T_A = 25^\circ\text{C}$ , 20mA)

COLOR	PARAMETER	SYMBOL	VALUE			UNIT
			MIN.	TYP.	MAX.	
Red	Forward voltage	$V_F$	1.8	-	2.4	V
	Intensity	$\Phi$	2.0	-	4.0	lm
	Dominant wavelength <sup>1</sup>	$\lambda$	615	-	625	nm
	View angle	$2\theta_{1/2}$	-	120	-	Deg
	Reverse current	$I_r$	-	-	1	$\mu\text{A}$
Green	Forward voltage	$V_F$	2.7	-	3.4	V
	Intensity	$\Phi$	5.0	-	7.0	lm
	Dominant wavelength	$\lambda$	515	-	525	nm
	View angle	$2\theta_{1/2}$	-	120	-	Deg
	Reverse current	$I_r$	-	-	1	$\mu\text{A}$
Blue	Forward voltage	$V_F$	2.7	-	3.4	V
	Intensity	$\Phi$	1.0	-	3.0	lm
	Dominant wavelength	$\lambda$	460	-	470	nm
	View angle	$2\theta_{1/2}$	-	120	-	Deg
	Reverse current	$I_r$	-	-	1	$\mu\text{A}$
5600K	Forward voltage	$V_F$	2.7	-	3.3	V
	Luminous flux	$\Phi_{3200\text{K}}$	5.0	-	8.0	lm
		$\Phi_{5600\text{K}}$	5.0	-	8.0	lm
	Correlated color temperature <sup>1</sup>	$\text{CCT}_{3200\text{K}}$	3000	3200	3400	K
		$\text{CCT}_{5600\text{K}}$	5300	5600	5900	K
	Color rendering index	Ra	-	95	-	-
	TCS R9 (CRI red)	R9	-	90	-	-
	Fidelity index <sup>2</sup>	Rf	-	92	-	-
	Gamut index <sup>2</sup>	Rg	-	100	-	-
	TLCI 2012 <sup>3</sup>	-	-	97	-	-
	View angle	$2\theta_{1/2}$	-	120	-	Deg
Reverse current	$I_r$	-	-	1	$\mu\text{A}$	
Reverse current	$I_r$	-	-	1	$\mu\text{A}$	

1. Yujileds® promises the chromaticity coordinate tolerance of  $\pm 0.0015$  (CIE 1931 x,y) based on Yuji standard equipment shall prevail.
2. Defined by the IES TM-30-18 method, this data is for trial.
3. Defined by the EBU, TLCI is the abbreviation of Television Lighting Consistency Index, this data is for trial.

## Characteristics

Absolute maximum ratings ( $T_A = 25^\circ\text{C}$ )

PARAMETER	SYMBOL	RED	GREEN	BLUE	White	UNIT
<b>Power Consumption (Simultaneous)</b>	$P_D$	44	96	96	96	mW
<b>DC Forward Current (Individual)</b>	$I_F$	20	30	30	30	mA
<b>Reverse Voltage</b>	$V_R$			5		V
<b>Operating Temperature</b>	$T_{opr}$			-40 ~ +85		$^\circ\text{C}$
<b>Storage Temperature</b>	$T_{stg}$			-40 ~ +85		$^\circ\text{C}$
<b>Junction Temperature</b>	$T_j$			100		$^\circ\text{C}$

## Chromaticity group and diagram

Chromaticity bins & coordinates

CCT	BIN	CIE 1931 COORDINATES							
		X0	Y0	X1	Y1	X2	Y2	X3	Y3
3200K	32N	0.4181	0.3888	0.4119	0.3959	0.4262	0.4090	0.4326	0.4021
5600K	56T	0.3242	0.3299	0.3234	0.3447	0.3376	0.3573	0.3370	0.3412

CIE 1931 diagram

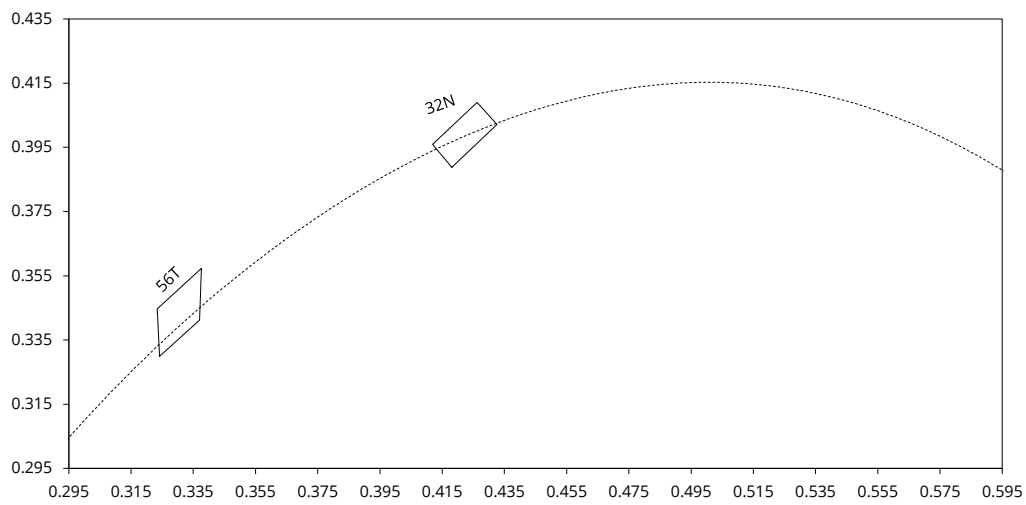

## Package material and dimension

### Package layout

All dimensions in mm, tolerance unless mentioned is  $\pm 0.15$ mm.

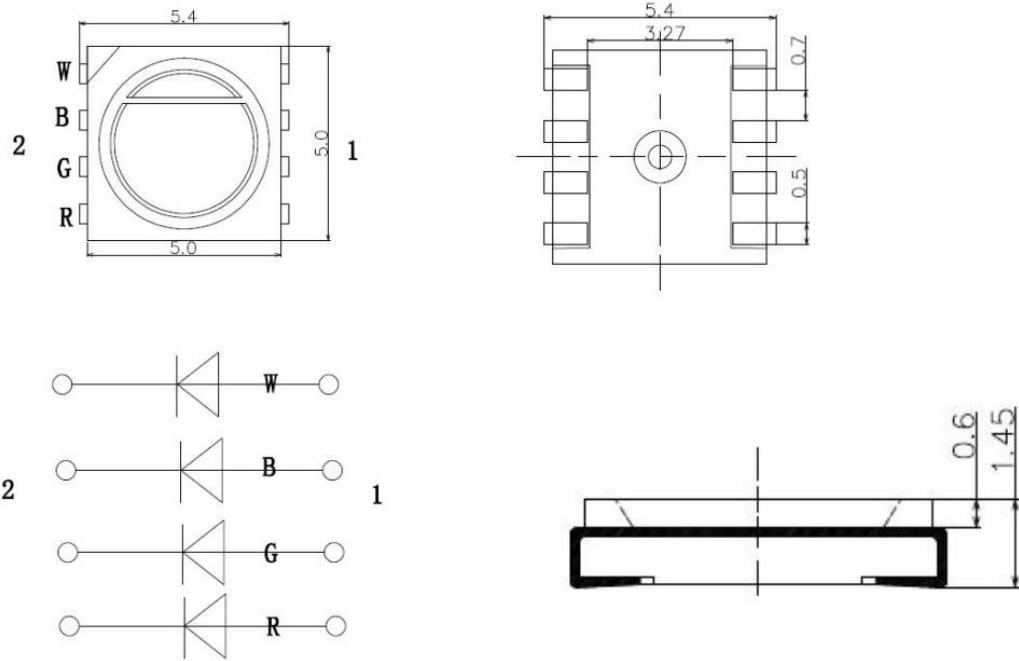



## Characteristic graph

Typical spectral power distribution (normalized)

All characteristic curves are for reference only and not guaranteed.

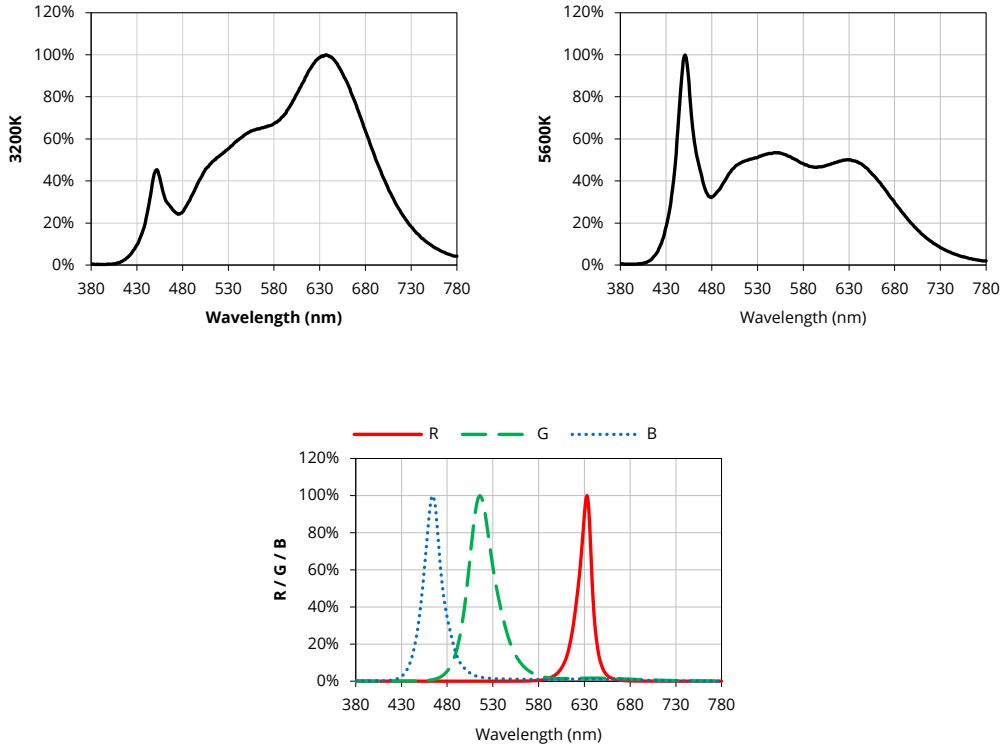

## Characteristic graph

Spatial distribution ( $T_A = 25^\circ\text{C}$ ,  $I_F = 20\text{mA}$ )

All characteristic curves are for reference only and not guaranteed.

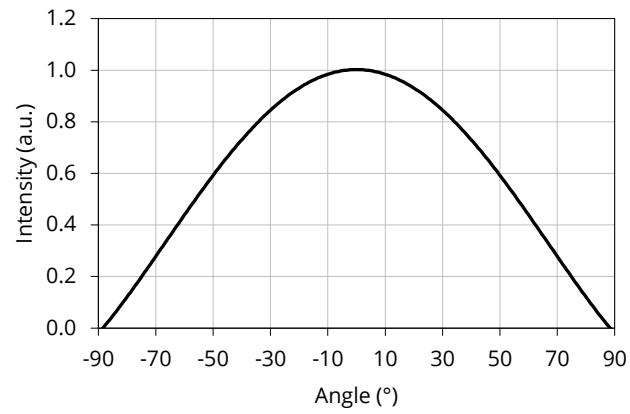

## Reflow profile

Soldering ramp-up time (Pb-FREE).

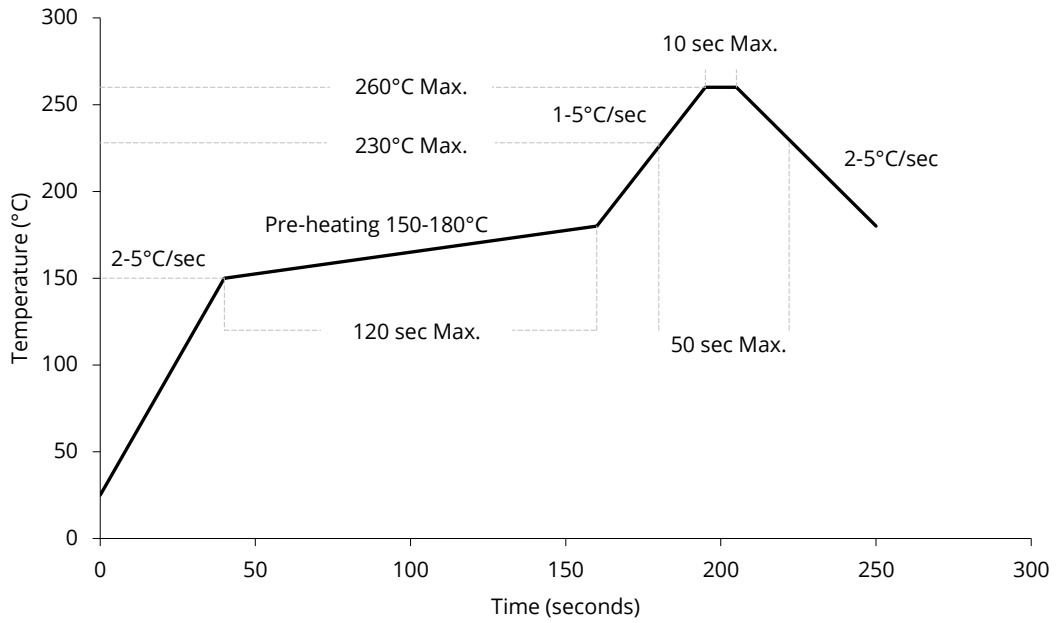

Note: Soldering paste with the melting point at 230°C is recommended.

---

## SMT instruction

### Problems caused by improper selection of collet

Choosing the right collet is important in ensuring product quality after SMT. LEDs are different from other electronic components, as they are not only concerned with electrical output but also optical output. This characteristic makes LEDs more fragile in the process of SMT. If the collet's lowering height is not well set, it will bring damage to the gold wire at the time of collet's pick-and-place process which can cause the LED to not illuminate, flicker or contribute to other quality problems, some of which may not be immediately detectable.

### Collet selection

During SMT, please choose the appropriate collet in order to avoid damage the gold wire inside the LED or insufficient suction. Setting the height of the collet is crucial in order to avoid damage to the top view SMD. If the collet setting is set to too low of an altitude, the collet will press down on the SMD, causing damage or breakage to the encapsulant and cause distortion or breakage of the gold wire.

### Other notes of caution

- No pressure should be exerted to the epoxy shell of the SMD under high temperature.
- Do not scratch or wipe the lens since the lens and gold wire inside are rather fragile and cross out easy to break.
- LED should be used as soon as possible when being taken out of the original package, and should be stored in anti-moisture and anti-ESD package.
- This usage and handling instructions are for reference only.

## About Yujileds



### The Yuji story

Yuji started with LED phosphor materials in 2006, and today we are known for nitride red LED phosphor with superior brightness and stability in the world. With the rapid growth in LED industry during the past years, we have serviced over 260 business customers in over 33 different countries or regions, and established subsidiaries or distributors in 6 locations including China, US, UK and Japan, now we are reaching the global markets with the full coverage efficiently.

### Our capabilities and achievements

In Yujileds®, we are a group of people passionate in creating the maximum value for customers. Dedicated to developing LED phosphor, LED light source and final products, we have accumulated unique experience in different projects. Nowadays, over 30 experts are gathered in a variety of areas including but not limited to semiconductor, chemistry, optics, photoelectricity, circuitry, materials and color science.

In commercial markets, we have been dedicating to providing comprehensive solutions for specific applications by deeply understanding these markets. Our goal is not only to offer an LED product simply but is to grow with customers and share the success of a business.

**Main website:** [www.yujiintl.com](http://www.yujiintl.com)

Find the comprehensive introduction of Yuji company and our insights into a variety of advanced technologies and applications.

Contact: [info@yujigroup.com](mailto:info@yujigroup.com)

**Subordinative website:** [www.yujileds.com](http://www.yujileds.com)

Find more about our products, technical posts, featured support and service, blogs, news and whatever interesting and practical information.

Contact: [contact@yujileds.com](mailto:contact@yujileds.com)

**Online shop:** [store.yujiintl.com](http://store.yujiintl.com)

Find your favorite Yujileds® products with outstanding quality, fast shipment and superb sale service.

Contact: [webstore@yujigroup.com](mailto:webstore@yujigroup.com)