



# YJ-BC-2835L-G03

Surface Mount Device

## Applications

- High-end architectural lighting
- Photographic/broadcast lighting
- Human-centric lighting
- Photoelectric device and relevant research



## Features

- Industrial high CRI performance
- 2.8mm × 3.5mm universal package
- Economical product solution
- Lifespan > 54000 hours (IES LM80)
- TLCI & TM-30 specified
- Exempt Risk Group certified (IEC 62471)
- SimpleBinning solution

[About Yujileds<sup>®</sup>](#)

Rev Version: 2.2

P3190005.00

## Table of Contents

<b>General description .....</b>	<b>3</b>
<b>Ordering information .....</b>	<b>7</b>
<b>Characteristics .....</b>	<b>8</b>
Electrical-optical characteristics ( $T_A = 25^\circ\text{C}$ , 60mA) .....	8
Absolute maximum ratings ( $T_A = 25^\circ\text{C}$ ) .....	9
<b>Chromaticity group and diagram .....</b>	<b>10</b>
Chromaticity bins & coordinates .....	10
CIE 1931 diagram.....	10
<b>Reliability .....</b>	<b>11</b>
<b>Package material and dimension.....</b>	<b>12</b>
Package layout.....	12
Package materials.....	12
<b>Characteristic graph .....</b>	<b>13</b>
Typical spectral power distribution (normalized).....	13
Forward current.....	15
Vs. forward voltage.....	15
Vs. relative luminous flux.....	15
Vs. relative chromaticity shift .....	16
Vs. absolute chromaticity shift .....	16
Derating based on solder point .....	16
Solder point temperature ( $T_s$ ).....	17
Vs. forward voltage.....	17
Vs. relative chromaticity shift .....	17
Vs. absolute chromaticity shift .....	17
Spatial distribution ( $T_A = 25^\circ\text{C}$ , $I_F = 60\text{mA}$ ) .....	18
<b>Solder and reflow profile .....</b>	<b>19</b>
Recommended solder pad layout.....	19
Reflow profile.....	19
<b>SMT instruction .....</b>	<b>20</b>
Problems caused by improper selection of collet.....	20

---

Collet selection.....	20
Other notes of caution.....	20
<b>Tape and reel specifications .....</b>	<b>21</b>
<b>Box packaging .....</b>	<b>23</b>
<b>About Yujileds .....</b>	<b>24</b>

## General description

### Industrial-leading high CRI technology

Yujileds® BC series LED is based on the efficient blue (typical 450nm) die, mixing with Yuji advanced phosphors and specifically designed spectral recipes. Although there are more and more nominal “high CRI LED” manufacturers on the market, after relevant test and analysis, it is proud to say that Yujileds® BC series LED is still one of the top performance product on the global markets. Achieving typical Ra 97 and minimum Ra 95, the stability and consistent quality in mass production are verified by statistical identification.

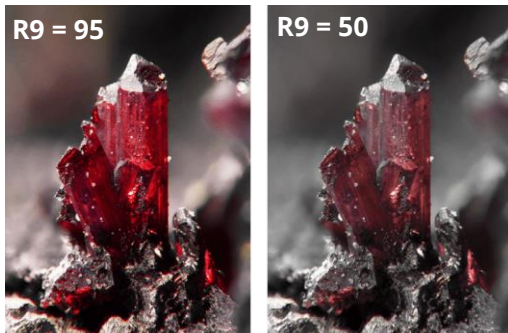
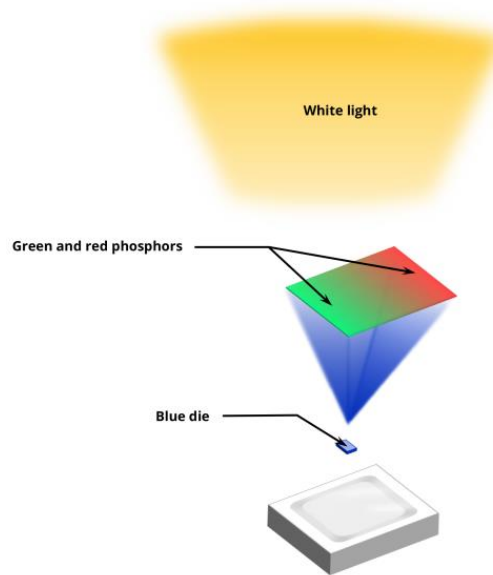

Light source	R9
Halogen (2865K)	99
Fluorescent (3000K)	-27
Standard LED (3000K)	13
Yujileds® BC series LED (3000K)	96

### Enhanced CRI R9 technology

The standard CRI Ra is the average score of the first eight Test Color Samples (TCS), where the 9th for saturated red color is missed. However R9 is significantly different for different light sources. In spectral analysis and CRI arithmetic, the integral area between the spectrum and the spectral reflectance response of TCS-9 decides the R9 to a large extent – in other words, how much of TCS-9 spectra reflectance is overlaid in the light source spectrum, that is a key factor.

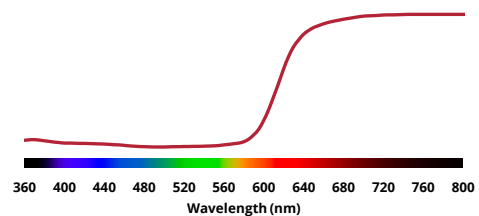

It is obvious to see from 600nm, which is just the start of red color in the visible spectrum, the TCS-9 spectral reflectance raises sharply, in consequence, if the light source does not have sufficient spectral power distribution in 600nm-800nm, it will be difficult to get a high

R9. The capability of rendering the red color cannot be promised if the red spectrum is missed or not sufficient in the original light. In the comparison of fluorescent and halogen, apparently, halogen offers the richest 600+nm power, while the discrete fluorescent spectrum has limited energy there. Then in this comparison, halogen R9 = 99 but the fluorescent is R9 = -27. Comparing a standard LED to Yujileds® BC series LED at 3000K, although the emission principle is the same, the results present different R9 significantly where the standard LED is R9 = 13 and Yujileds® BC series LED is R9 = 96.

**Transcend high CRI**

High CRI becomes the tendency for LED products in recent years, and manufacturers start providing “nominal” high CRI LED to the market, however, as the result of a detailed investigation, most manufacturers’ high CRI LED are limited in the range of 2700K-5000K, where lower and higher CCTs are missed when applying to more specific applications. Yujileds® BC series LED extends high CRI performance from 1800K to 20000K CCT.

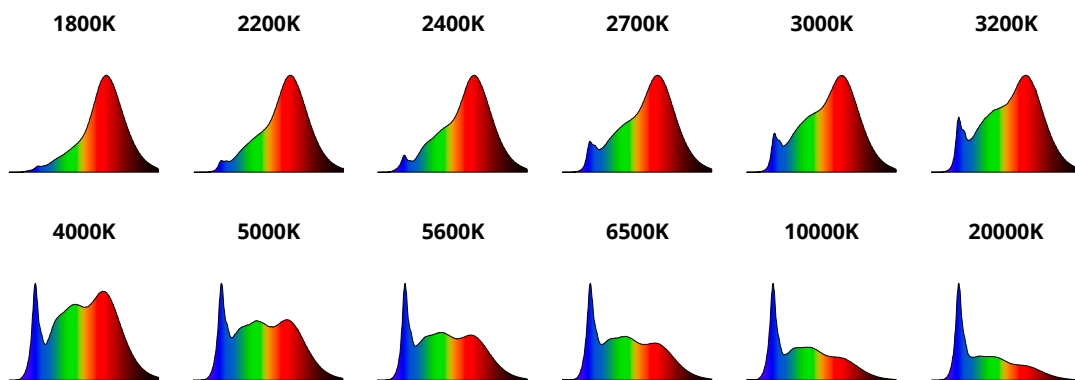

In comparison to a standard LED on the market is generally in the available CCT range of 2700K-6500K, and high CRI LEDs are more limited to fewer options, Yujileds® BC series LED can be extended to 1800K-20000K with the unique phosphor solutions, maintaining the CRI still above 92-97 and excellent spectral qualities. Moreover, looking into the specific Ri in each CCT, the color rendition is well balanced without significant difference, even for the extreme CCTs. Therefore, the CRI is always consistent regardless of what CCT we combine with the BC series LEDs.

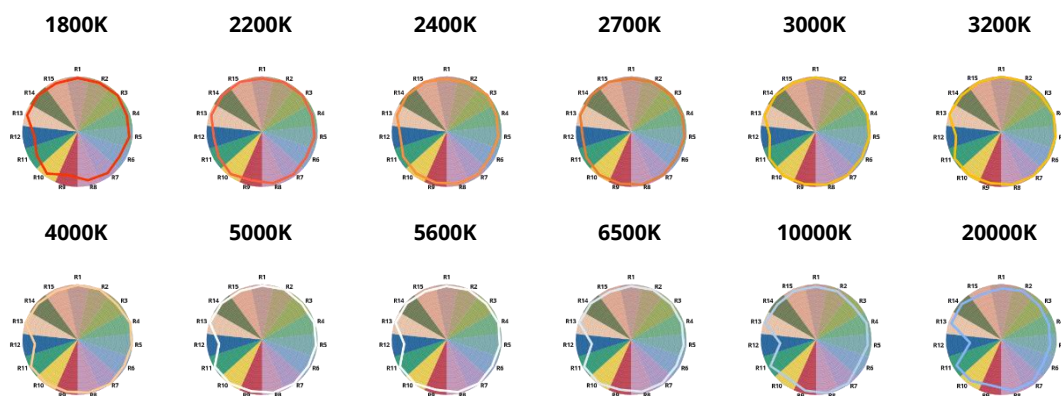

**CRI statistic support - introducing the plot box statistics.**

In actual applications, LED can work individually or as a group on a printed circuit board, therefore the consistent CRI is critical for both. Generally, a manufacturer only provides a typical datasheet or report to infer the overall performance but the risk is that if some LEDs in a batch have worse CRI but the typical report cannot match, especially when the application uses fewer LEDs which means CRI is difficult to be averaged with those higher ones, then the risk falls to the customers' lighting fixture.

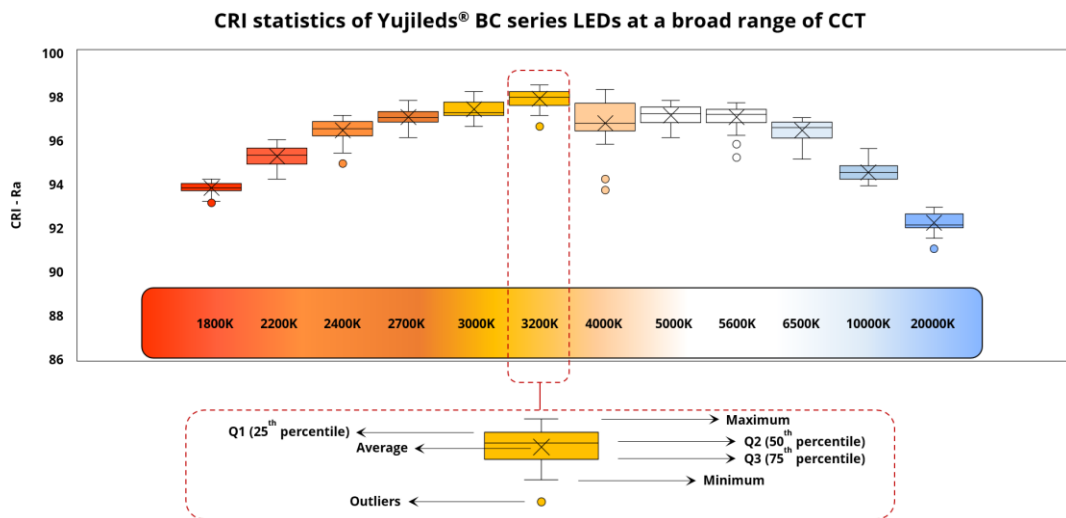

Understanding the statistical features of LED and processing relevant analysis and control are important in this case, and these are what we do for our BC series LED. We provide the full statistic and data support from the production of 1,000,000pcs of each CCT from 1800K to 20000K, and present all characteristics and guidance for customers to make reliable simulation and prediction accordingly. And from the statistical data, we can also read that the BC series LED perform excellently on the CRI consistency.

The BC series 2835L LED also supports the unique service/certification by Yujileds® as described below.



**TM-30-18 specification**

The most advanced colorimetric for color rendition, widely recognized as the successor of CRI.



**TLCI specification**

Based on the Macbeth ColorChecker, for evaluating the colorimetric quality of the broadcast lighting.

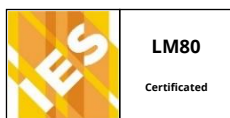

**IESNA LM-80-08 certification**

9000 hours data of chromaticity shift and TM-21 reported L70 lifetime at 55°C, 85°C and 105°C.

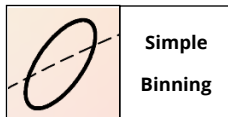

**Simple  
Binning**

#### **SimpleBinning specification**

Simplify the chromaticity binning with TrueChroma data support to provide the most economical, simple, and practical solution to customers.



**Exempt  
Group**

#### **IEC 62471:2006 certification**

Result in the Exempt Group (RG0) for reliable photobiological safety at the rated power.



**RoHS  
Compliance**

#### **RoHS 2011/65/EU compliance**

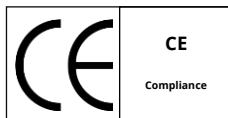

**CE  
Compliance**

#### **CE compliance**



**REACH  
Compliance**

#### **REACH compliance (Phosphor)**

## Ordering information

PART NUMBER	PRODUCT CODE	CCT	CHROMATICITY BINS	VOLTAGE RANGE
<b>YJ-BC-2835L-G03-18</b>	P3190005.18	1800K	18M	0.1V
<b>YJ-BC-2835L-G03-22</b>	P3190005.22	2200K	22M	0.1V
<b>YJ-BC-2835L-G03-24</b>	P3190005.24	2400K	24M	0.1V
<b>YJ-BC-2835L-G03-27</b>	P3190005.27	2700K	27M	0.1V
<b>YJ-BC-2835L-G03-30</b>	P3190005.30	3000K	30M	0.1V
<b>YJ-BC-2835L-G03-32</b>	P3190005.32	3200K	32M	0.1V
<b>YJ-BC-2835L-G03-40</b>	P3190005.40	4000K	40M	0.1V
<b>YJ-BC-2835L-G03-50</b>	P3190005.50	5000K	50M	0.1V
<b>YJ-BC-2835L-G03-56</b>	P3190005.56	5600K	56M	0.1V
<b>YJ-BC-2835L-G03-65</b>	P3190005.65	6500K	65M	0.1V
<b>YJ-BC-2835L-G03-100</b>	P3190005.01	10000K	100M	0.1V
<b>YJ-BC-2835L-G03-200</b>	P3190005.02	20000K	200M	0.1V
<b>YJ-BC-2835L-G03-XX</b>	P3190005.XX	Custom CCT	-	0.1V



## Characteristics

Electrical-optical characteristics ( $T_A = 25^\circ\text{C}$ , 60mA)

PARAMETER	SYMBOL	VALUE			UNIT	TOLERANCE
		MIN.	TYP.	MAX.		
<b>Forward voltage</b>	$V_F$	2.8	-	3.2	V	$\pm 0.05$
<b>Luminous flux</b>	$\Phi_{1800K}$	13	-	16	lm	-
	$\Phi_{2200K}$	14	-	17		
	$\Phi_{2400K}$	15	-	18		
	$\Phi_{2700K}$	15	-	18		
	$\Phi_{3000K}$	17	-	18		
	$\Phi_{3200K}$	17	-	20		
	$\Phi_{4000K}$	18	-	21		
	$\Phi_{5000K}$	18	-	21		
	$\Phi_{5600K}$	19	-	22		
	$\Phi_{6500K}$	19	-	22		
	$\Phi_{10000K}$	20	-	23		
	$\Phi_{20000K}$	19	-	22		
<b>Correlated color temperature<sup>1</sup></b>	$CCT_{1800K}$	1700	-	1900	K	-
	$CCT_{2200K}$	2100	-	2300		
	$CCT_{2400K}$	2300	-	2500		
	$CCT_{2700K}$	2550	-	2850		
	$CCT_{3000K}$	2850	-	3150		
	$CCT_{3200K}$	3050	-	3350		
	$CCT_{4000K}$	3800	-	4200		
	$CCT_{5000K}$	4800	-	5200		
	$CCT_{5600K}$	5300	-	5900		
$CCT_{6500K}$	6000	-	7000			
<b>Color rendering index</b>	Ra	95 <sup>2</sup>	-	-	-	$\pm 1$
<b>TCS R9 (CRI red)</b>	R9	-	90	-	-	-
<b>Fidelity index<sup>3</sup></b>	Rf	-	92	-	-	-
<b>Gamut index<sup>3</sup></b>	Rg	-	100	-	-	-
<b>TLCI 2012<sup>4</sup></b>	-	-	97	-	-	-
<b>Reverse current</b>	$I_r$	-	-	10	$\mu\text{A}$	$\pm 0.1 (V_r = 5V)$
<b>View angle</b>	$2\theta_{1/2}$	-	120	-	Deg	$\pm 5$
<b>Thermal resistance</b>	$R_{\theta JS}$	-	20 <sup>5</sup>	-	$^\circ\text{C/W}$	-

1. Yujileds® promises the chromaticity coordinate tolerance of  $\pm 0.0015$  (CIE 1931 x,y) based on Yuji standard equipment shall prevail.

2. Ra minimum 93 at 1800K, 2200K and 6500K, minimum 90 at 10000K and 20000K.
3. Defined by the IES TM-30-18 method, this data is for trial.
4. Defined by the EBU, TLCI is the abbreviation of Television Lighting Consistency Index, this data is for trial.
5. This data is for reference only.

## Characteristics

Absolute maximum ratings ( $T_A = 25^\circ\text{C}$ )

PARAMETER	SYMBOL	LIMIT	UNIT
<b>Power Consumption</b>	$P_D$	300	mW
<b>DC Forward Current (pulsed)<sup>1</sup></b>	$I_{FP}$	$180^2$	mA
<b>DC Forward Current</b>	$I_F$	90	mA
<b>Reverse Voltage</b>	$V_R$	5	V
<b>Junction Temperature</b>	$T_j$	125	$^\circ\text{C}$
<b>Solder Point Temperature<sup>3</sup></b>	$T_s$	105	$^\circ\text{C}$
<b>Operating Temperature</b>	$T_{opr}$	-40 ~ +85	$^\circ\text{C}$
<b>Storage Temperature</b>	$T_{stg}$	-30 ~ +85	$^\circ\text{C}$
<b>Soldering Temperature</b>	$T_{sol}$	$260 \pm 5$	$^\circ\text{C}$
<b>Reflow Cycles Allowed</b>	-	2	-

1. Pulse width  $\leq 0.1\text{ms}$ , duty  $\leq 1/10$ .
2. Theoretical data.
3. See page [Package material and dimension](#).

## Chromaticity group and diagram

### Chromaticity bins & coordinates

CCT	BIN	CIE 1931 COORDINATES							
		X0	Y0	X1	Y1	X2	Y2	X3	Y3
1800K	18M	0.5452	0.4192	0.5310	0.4032	0.5530	0.3960	0.5680	0.4130
2200K	22M	0.5035	0.4235	0.4919	0.4072	0.5070	0.4066	0.5195	0.4226
2400K	24M	0.4842	0.4223	0.4740	0.4062	0.4873	0.4072	0.4985	0.4232
2700K	27M	0.4582	0.4174	0.4494	0.4012	0.4610	0.4035	0.4704	0.4195
3000K	30M	0.4352	0.4100	0.4278	0.3935	0.4387	0.3978	0.4470	0.4142
3200K	32M	0.4220	0.4052	0.4155	0.3891	0.4250	0.3926	0.4321	0.4087
4000K	40M	0.3757	0.3808	0.3723	0.3643	0.3853	0.3730	0.3901	0.3892
5000K	50M	0.3400	0.3548	0.3394	0.3396	0.3501	0.3487	0.3517	0.3637
5600K	56M	0.3257	0.3420	0.3262	0.3285	0.3346	0.3358	0.3348	0.3506
6500K	65M	0.3088	0.3255	0.3108	0.3140	0.3182	0.3218	0.3170	0.3338
10000K	100M	0.2749	0.2892	0.2769	0.2777	0.2865	0.2876	0.2852	0.2995
20000K	200M	0.2510	0.2596	0.2515	0.2463	0.2621	0.2554	0.2623	0.2702

### CIE 1931 diagram

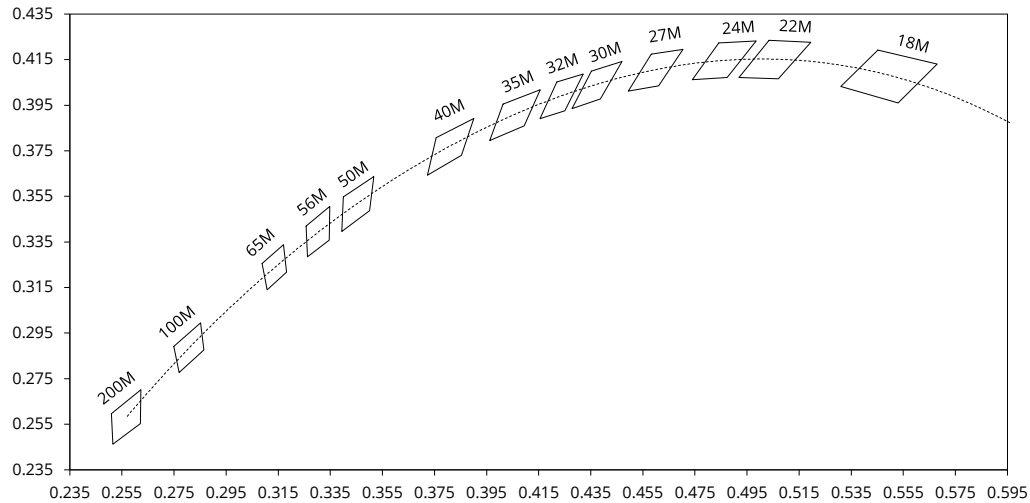

Reliability<sup>1</sup>

$T_s = 55^\circ\text{C}$ ,  $I_F = 60\text{mA}$ ,  $\text{RH} < 65\%$ , reported  $L70 > 54000$  hours<sup>2</sup>

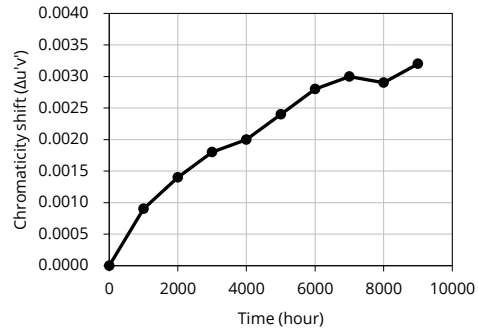
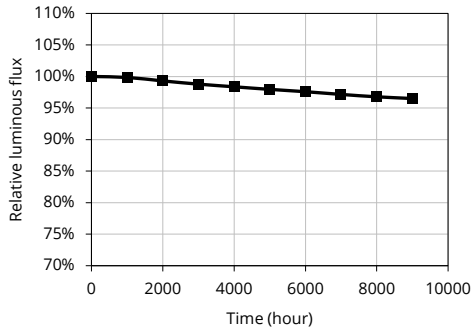

$T_s = 85^\circ\text{C}$ ,  $I_F = 60\text{mA}$ ,  $\text{RH} < 65\%$ , reported  $L70 > 54000$  hours

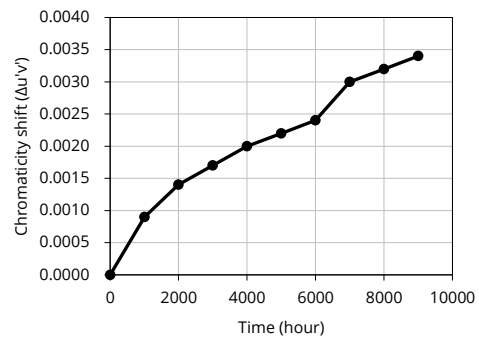
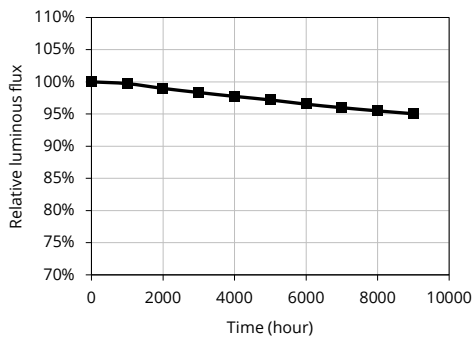

$T_s = 105^\circ\text{C}$ ,  $I_F = 60\text{mA}$ ,  $\text{RH} < 65\%$ , reported  $L70 = 52000$  hours

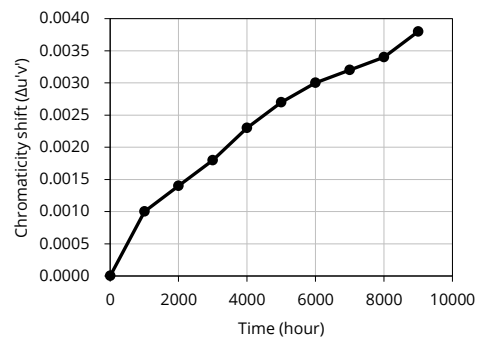
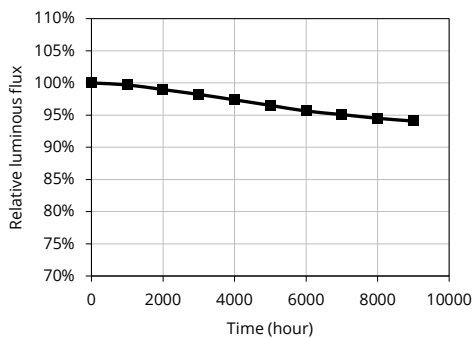

1. Data from IESNA LM-80-2008, report number R2DG150122050-10-9000.
2. Yujileds® reserves all the right for final explanation of reliability.

## Package material and dimension

### Package layout

All dimensions in mm, tolerance unless mentioned is  $\pm 0.1$ mm.

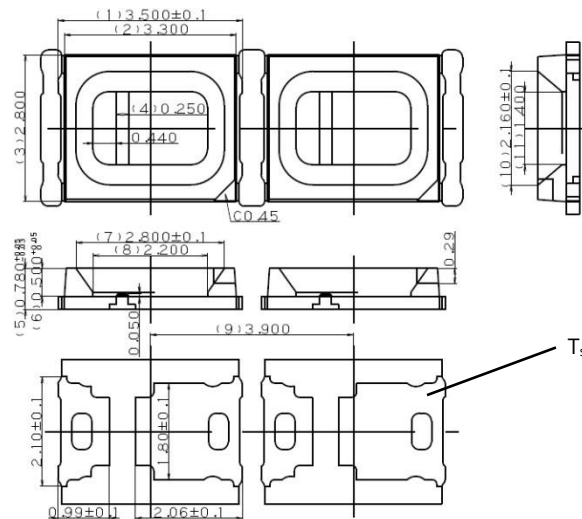

### Package materials

ITEM	DESCRIPTION
Die material	InGaN
Lead frame material	PPA
Encapsulant resin material	Silicon + Phosphor
Electrodes material	Silver-plated copper

## Characteristic graph

Typical spectral power distribution (normalized)

All characteristic curves are for reference only and not guaranteed.

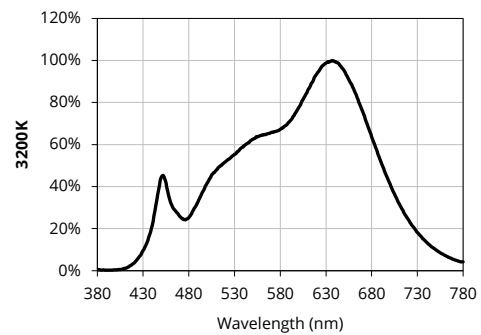
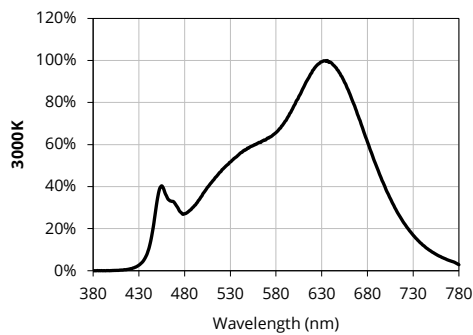
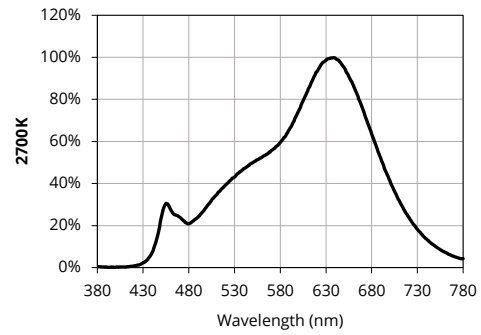
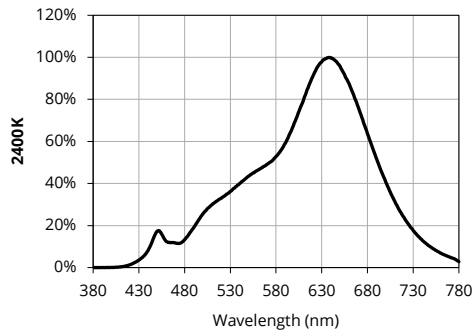
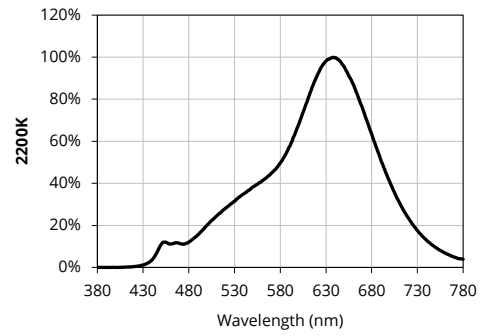
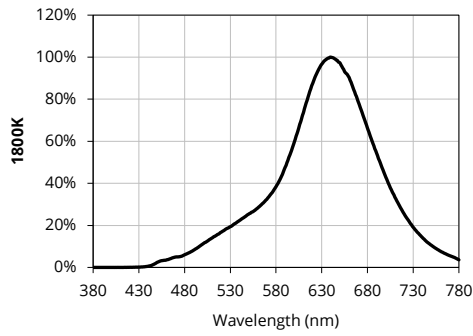

## Characteristic graph

### Typical spectral power distribution (normalized) (continued)

All characteristic curves are for reference only and not guaranteed.

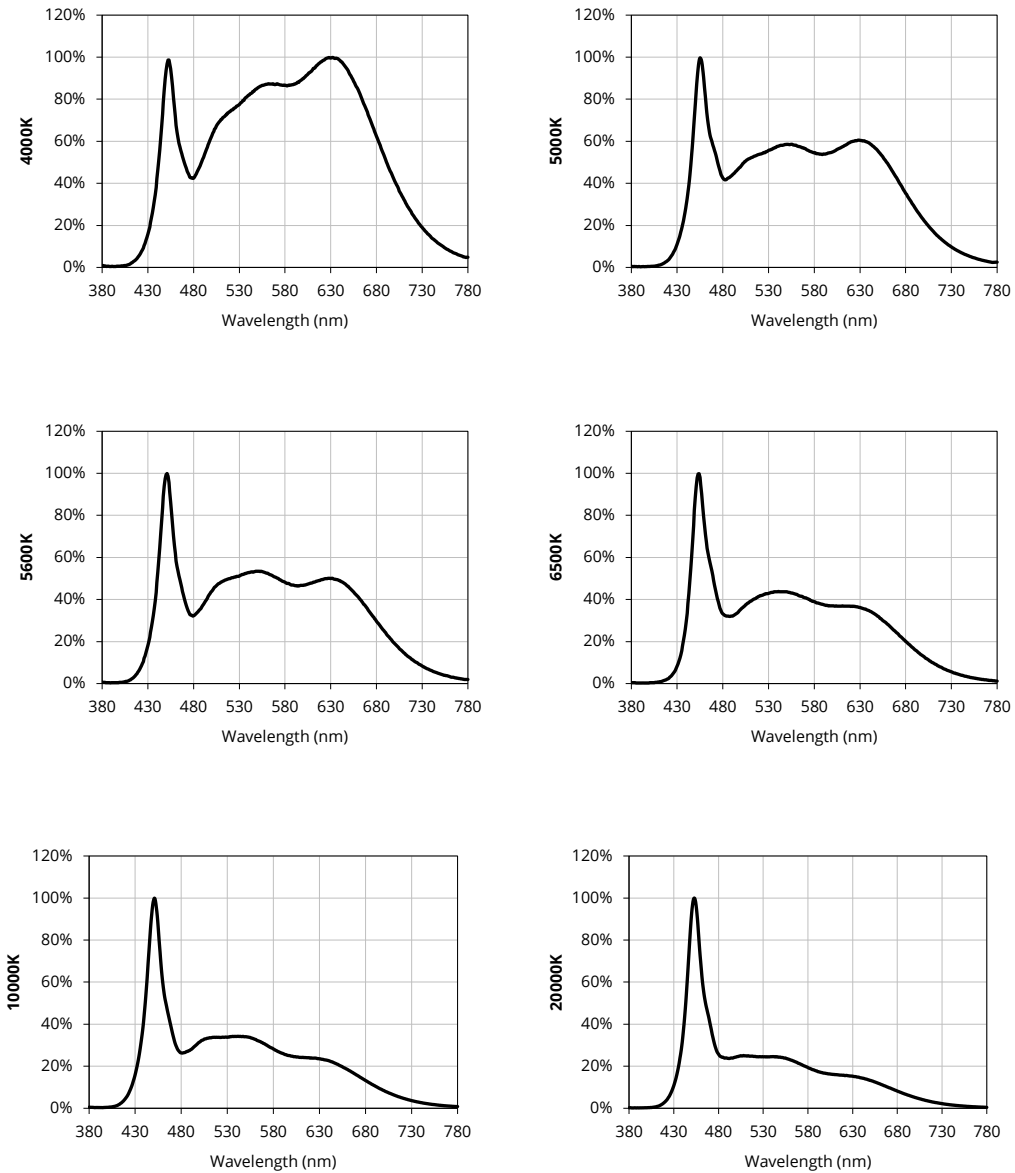

## Characteristic graph

### Forward current

All characteristic curves are for reference only and not guaranteed.

Vs. forward voltage

( $T_A = 25^\circ\text{C}$ )

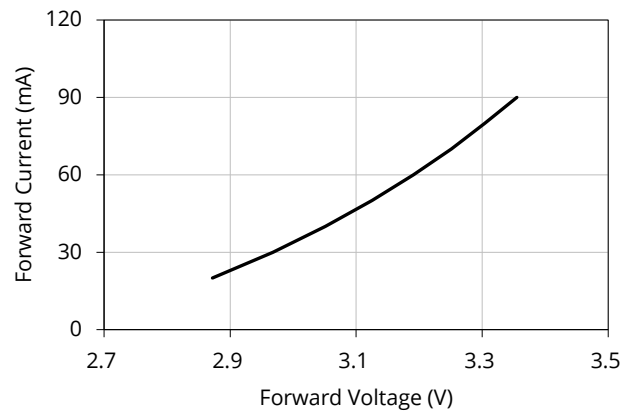

Vs. relative luminous flux

( $T_A = 25^\circ\text{C}$ )

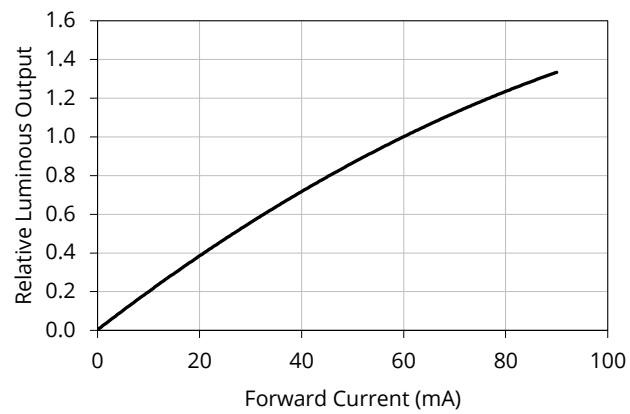



## Characteristic graph

### Forward current (continued)

All characteristic curves are for reference only and not guaranteed.

Vs. relative chromaticity shift

(3200K,  $T_A = 25^\circ\text{C}$ )

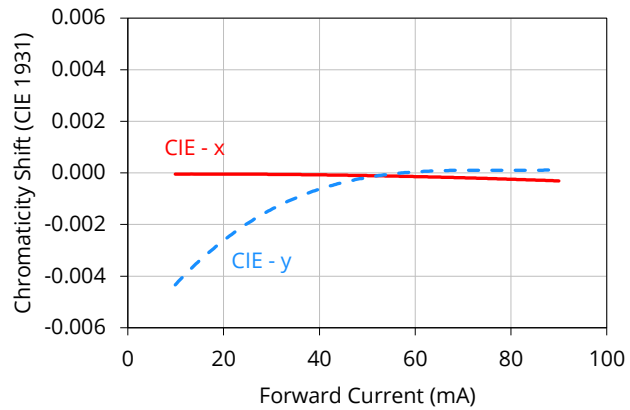

Vs. absolute chromaticity shift

(3200K,  $T_A = 25^\circ\text{C}$ )

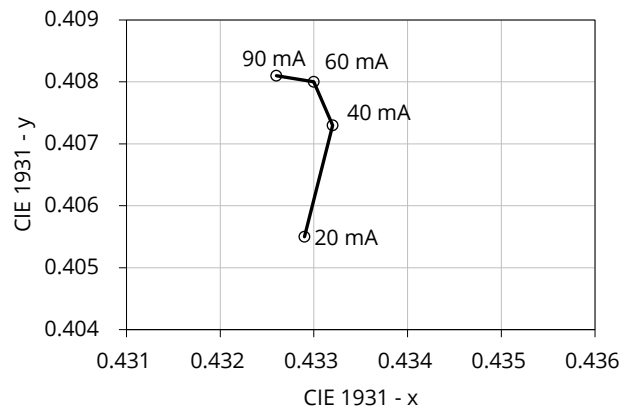

Derating based on solder point

Note: De-rating curves are meant for recommendation only and are not meant to provide guarantees of product stability and longevity.

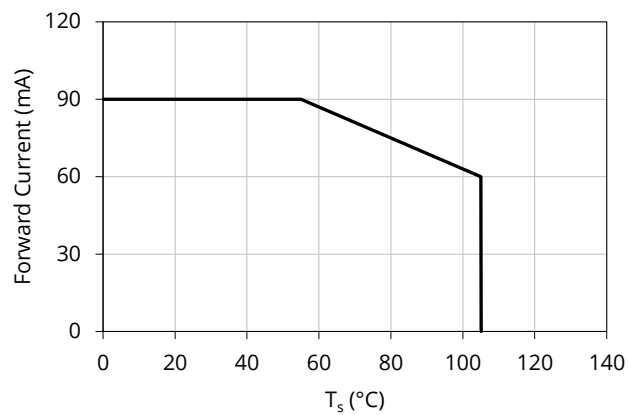

## Characteristic graph

### Solder point temperature ( $T_s$ )

All characteristic curves are for reference only and not guaranteed.

Vs. forward voltage

( $I_F = 60\text{mA}$ )

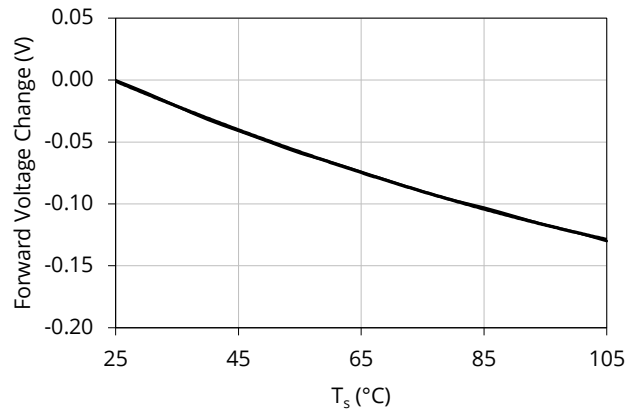

Vs. relative chromaticity shift

(5600K,  $I_F = 60\text{mA}$ )

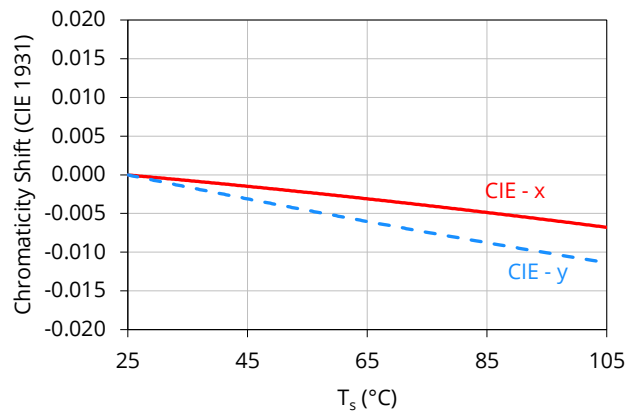

Vs. absolute chromaticity shift

(5600K,  $I_F = 60\text{mA}$ )

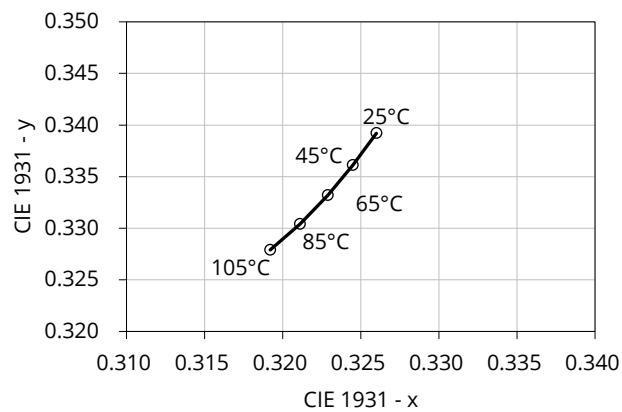

## Characteristic graph

Spatial distribution ( $T_A = 25^\circ\text{C}$ ,  $I_F = 60\text{mA}$ )

All characteristic curves are for reference only and not guaranteed.

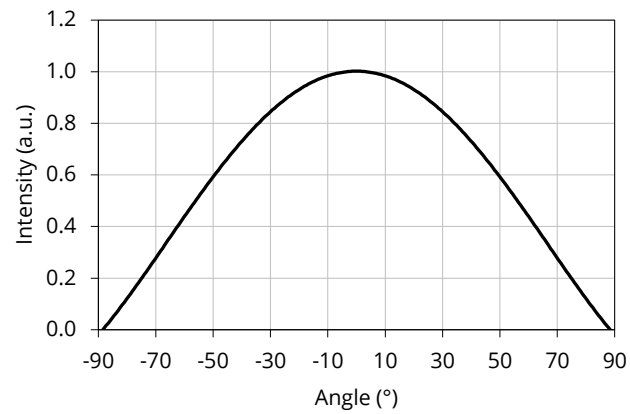

## Solder and reflow profile

### Recommended solder pad layout

All dimensions in mm, tolerance unless mentioned is  $\pm 0.1$ mm.

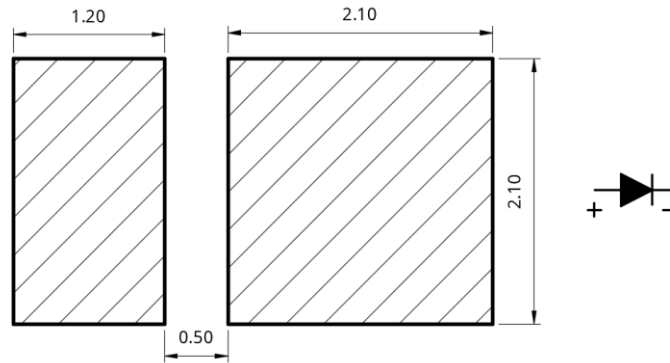

### Reflow profile

Soldering ramp-up time (Pb-FREE).

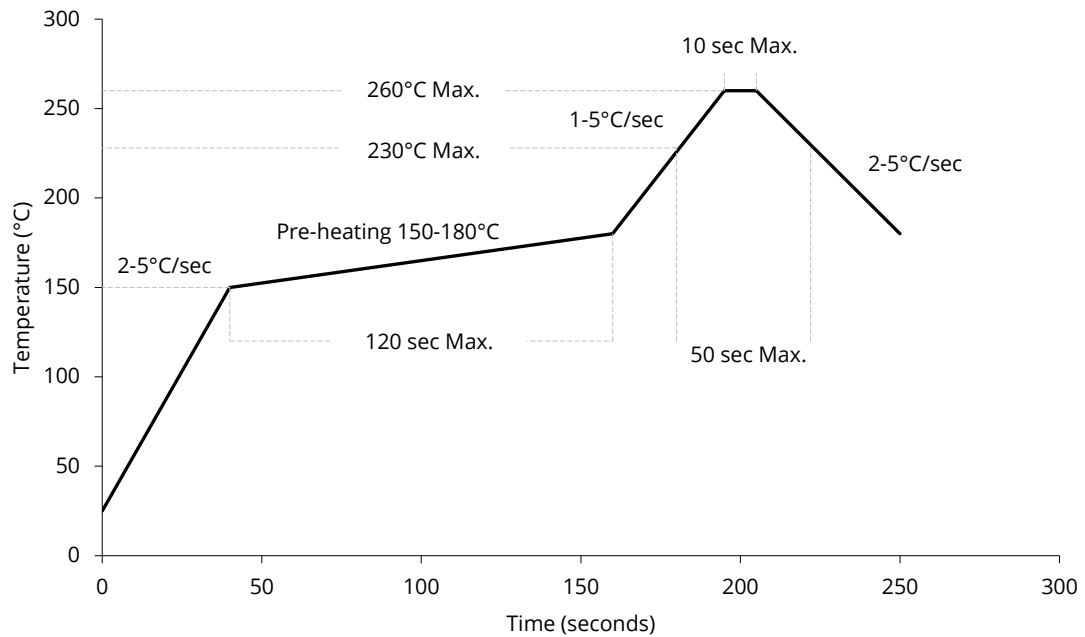

Note: Soldering paste with the melting point at 230°C is recommended.

---

## SMT instruction

### Problems caused by improper selection of collet

Choosing the right collet is important in ensuring product quality after SMT. LEDs are different from other electronic components, as they are not only concerned with electrical output but also optical output. This characteristic makes LEDs more fragile in the process of SMT. If the collet's lowering height is not well set, it will bring damage to the gold wire at the time of collet's pick-and-place process which can cause the LED to not illuminate, flicker or contribute to other quality problems, some of which may not be immediately detectable.

### Collet selection

During SMT, please choose the appropriate collet in order to avoid damage the gold wire inside the LED or insufficient suction. Setting the height of the collet is crucial in order to avoid damage to the top view SMD. If the collet setting is set to too low of an altitude, the collet will press down on the SMD, causing damage or breakage to the encapsulant and cause distortion or breakage of the gold wire.

### Other notes of caution

- No pressure should be exerted to the epoxy shell of the SMD under high temperature.
- Do not scratch or wipe the lens since the lens and gold wire inside are rather fragile and cross out easy to break.
- LED should be used as soon as possible when being taken out of the original package, and should be stored in anti-moisture and anti-ESD package.
- This usage and handling instructions are for reference only.

## Tape and reel specifications

Tape dimensions (unit: mm)

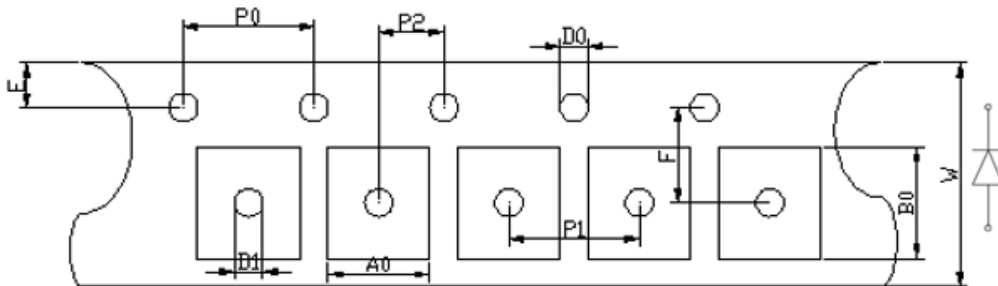

<b>Code</b>	W	A0	B0	E	F
<b>Value</b>	8.000	3.100	3.700	1.750	3.500
<b>Tolerance</b>	±0.100	±0.100	±0.100	±0.100	±0.050
<b>Code</b>	D0	D1	P0	P1	P2
<b>Value</b>	1.500	1.000	4.000	4.000	2.000
<b>Tolerance</b>	±0.100	±0.100	±0.100	±0.100	±0.050

## Tape layout

Not drawn to scale.

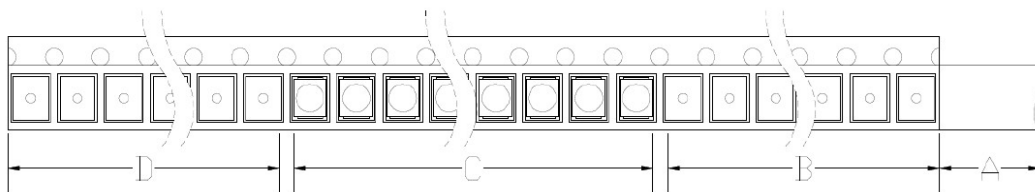

- A: Cover tape, 300mm;
- B: Empty leader, 200mm;
- C: LED, 4000pcs/5000pcs;
- D: Empty trailer, 200mm.

**Tape and reel specifications**

Reel dimensions top (unit: mm)

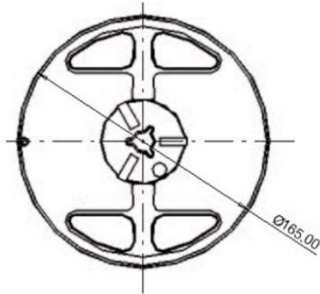

Reel dimensions bottom (unit: mm)

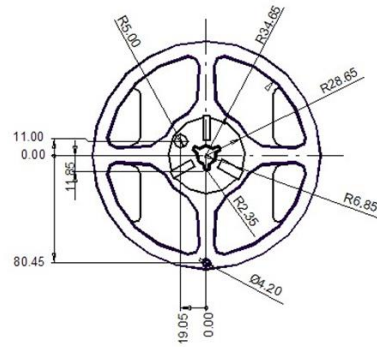

Reel dimensions side (unit: mm)

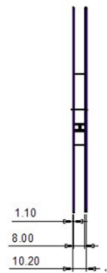

Feeding direction

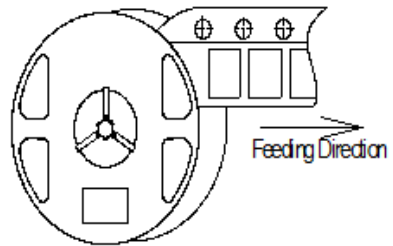

## Box packaging

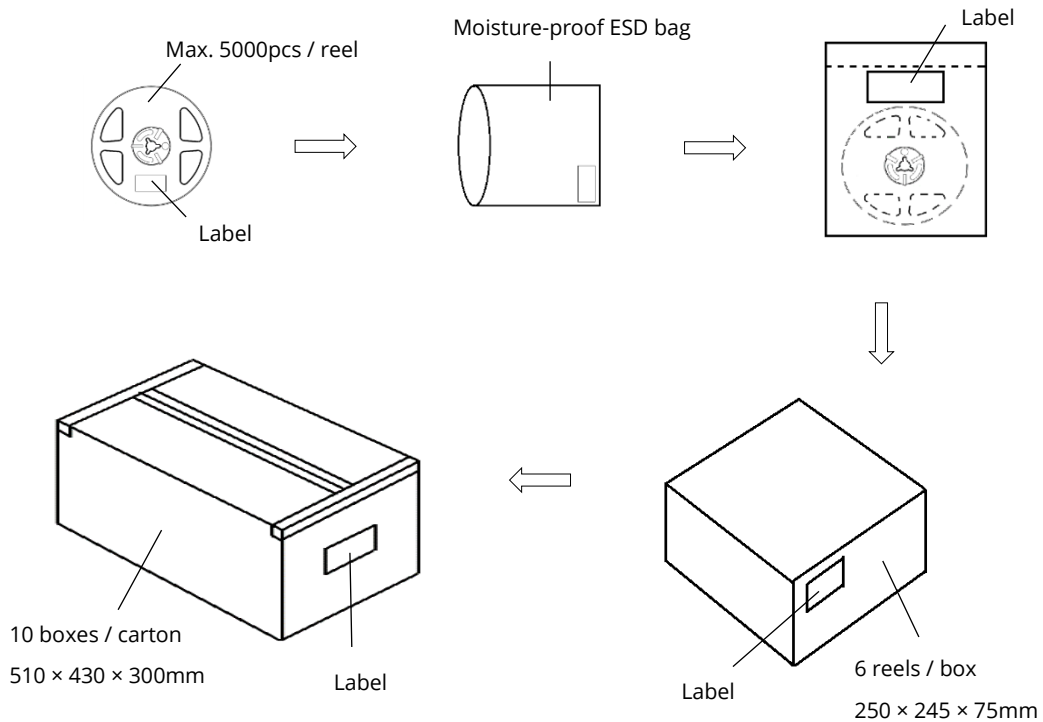

- Reeled products (max 5000pcs / reel) are packed in a moisture-proof bag along with a moisture desiccant pack.
- Each inner box contains up to 6 moisture-proof bag (total maximum number of SMDs is 30000pcs). Box package size: 250 mm × 245 mm × 75 mm.
- Each outer package contains 10 inner boxes. Box size: 510 mm × 430 mm × 300 mm.
- Outer package is sealed with protective bubble wrap and foam. (Part numbers, lot numbers, quantity should appear on the label on the moisture-proof bag, part numbers).
- This packaging merely intended as a reference for standard quantity orders only – please note that actual packaging can differ depending on the order circumstances.



## About Yujileds



### The Yuji story

Yuji started with LED phosphor materials in 2006, and today we are known for nitride red LED phosphor with superior brightness and stability in the world. With the rapid growth in LED industry during the past years, we have serviced over 260 business customers in over 33 different countries or regions, and established subsidiaries or distributors in 6 locations including China, US, UK and Japan, now we are reaching the global markets with the full coverage efficiently.

### Our capabilities and achievements

In Yujileds®, we are a group of people passionate in creating the maximum value for customers. Dedicated to developing LED phosphor, LED light source and final products, we have accumulated unique experience in different projects. Nowadays, over 30 experts are gathered in a variety of areas including but not limited to semiconductor, chemistry, optics, photoelectricity, circuitry, materials and color science.

In commercial markets, we have been dedicating to providing comprehensive solutions for specific applications by deeply understanding these markets. Our goal is not only to offer an LED product simply but is to grow with customers and share the success of a business.

**Main website:** [www.yujiintl.com](http://www.yujiintl.com)

Find the comprehensive introduction of Yuji company and our insights into a variety of advanced technologies and applications.

Contact: [info@yujigroup.com](mailto:info@yujigroup.com)

**Subordinative website:** [www.yujileds.com](http://www.yujileds.com)

Find more about our products, technical posts, featured support and service, blogs, news and whatever interesting and practical information.

Contact: [contact@yujileds.com](mailto:contact@yujileds.com)

**Online shop:** [store.yujiintl.com](http://store.yujiintl.com)

Find your favorite Yujileds® products with outstanding quality, fast shipment and superb sale service.

Contact: [webstore@yujigroup.com](mailto:webstore@yujigroup.com)