



YJ-NR-2835HP-G02

Surface Mount Device

Applications

- Horticulture lighting



Features

- Enhanced blue and red light for the coverage of Photosynthetically Active Radiation (PAR)
- Photosynthetic photon flux (PPF) 0.88 $\mu\text{mol/s}$ @150mA
- Photosynthetic efficacy 2.07 $\mu\text{mol/J}$ @150mA
- 2.8mm \times 3.5mm universal package
- Lifespan > 54000 hours (IES LM80)
- SimpleBinning solution

[About Yujileads[®]](#)

Rev Version: 2.1

P3200020.00

Table of Contents

General description	4
Ordering information	5
Characteristics	6
Electrical-optical characteristics ($T_A = 25^\circ\text{C}$, 150mA)	6
Absolute maximum ratings ($T_A = 25^\circ\text{C}$)	7
Chromaticity group and diagram	8
Chromaticity bins & coordinates	8
CIE 1931 diagram.....	8
Reliability	9
Package material and dimension.....	10
Package layout.....	10
Package materials.....	10
Characteristic graph	11
Typical spectral power distribution (normalized).....	11
Forward current.....	12
Vs. forward voltage.....	12
Vs. relative luminous flux.....	12
Vs. relative chromaticity shift	13
Vs. absolute chromaticity shift.....	13
Derating based on solder point	13
Solder point temperature (T_s).....	14
Vs. forward voltage.....	14
Vs. relative luminous flux.....	14
Vs. relative chromaticity shift	14
Vs. absolute chromaticity shift.....	15
Spatial distribution ($T_A = 25^\circ\text{C}$, $I_F = 150\text{mA}$).....	16
Solder and reflow profile	17
Recommended solder pad layout.....	17
Reflow profile.....	17
SMT instruction	18

Problems caused by improper selection of collet.....	18
Collet selection.....	18
Other notes of caution.....	18
Tape and reel specifications	19
Box packaging	21
About Yujileds	22

General description

Yujileds® Nourish series 2835 LED is designed for high photosynthetic efficacy performance in horticulture lighting. Manufactured with the blue (typical 450nm) die, mixing with Yuji advanced phosphors for specifically designed spectral recipes. It is one of the most economical solutions of low-power but provides industrial highest photosynthetic efficacy.

The Nourish series 2835 LED also supports the unique service/certification by Yujileds® as described below.



IESNA LM-80-08 certification

9000 hours data (60mA) of chromaticity shift and TM-21 reported L70 lifetime at 55°C, 85°C and 105°C.

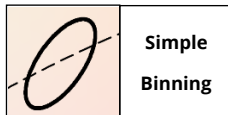

SimpleBinning specification

Simplify the chromaticity binning with TrueChroma data support to provide the most economical, simple, and practical solution to customers.



RoHS 2011/65/EU compliance



CE compliance



REACH compliance (Phosphor)

Ordering information

PART NUMBER	PRODUCT CODE	BLUE to RED RATIO	CHROMATICITY BINS	VOLTAGE RANGE
YJ-NR-2835HP-G02-BR-P1	P3200020.01	0.5 : 1	P1	0.1V
YJ-NR-2835HP-G02-BR-P2	P3200020.02	0.75 : 1	P2	0.1V
YJ-NR-2835HP-G02-BR-P3	P3200020.03	1 : 1	P3	0.1V
YJ-NR-2835HP-G02-BR-XX	P3200020. XX	Custom	-	0.1V

Characteristics

Electrical-optical characteristics ($T_A = 25^\circ\text{C}$, 150mA)

PARAMETER	SYMBOL	VALUE			UNIT	TOLERANCE
		MIN.	TYP.	MAX.		
Forward voltage	V_F	-	2.9	-	V	± 0.05
Luminous flux	Φ	-	17	-	lm	-
Correlated color temperature⁽¹⁾	CCT	-	1000	-	K	-
Radiant flux	Φ_e	190	-	-	mW	-
Photosynthetic photon flux	PPF_{P1}	-	0.88	-	$\mu\text{mol/s}$	-
	PPF_{P2}	-	0.90	-		-
	PPF_{P3}	-	0.92	-		-
Photosynthetic Photon Efficacy	PPE_{P1}	-	2.07	-	$\mu\text{mol/J}$	-
	PPE_{P2}	-	2.11	-		-
	PPE_{P3}	-	2.17	-		-
Biologically-active photon flux	BPF_{P1}	-	1.09	-	$\mu\text{mol/s}$	-
	BPF_{P2}	-	1.11	-		-
	BPF_{P3}	-	1.14	-		-
Biologically-active photon Efficacy	$BPFE_{P1}$	-	2.58	-	$\mu\text{mol/J}$	-
	$BPFE_{P2}$	-	2.63	-		-
	$BPFE_{P3}$	-	2.70	-		-
Reverse current	I_r	-	-	10	μA	$\pm 0.1 (V_r = 5V)$
View angle	$2\theta_{1/2}$	-	120	-	Deg	± 5
Thermal resistance	$R_{\theta JS}$	-	15 ⁽²⁾	-	$^\circ\text{C/W}$	-

(1). Yujileds® promises the chromaticity coordinate tolerance of ± 0.0015 (CIE 1931 x,y) based on Yuji standard equipment shall prevail.

(2). This data is for reference only.

Characteristics

Absolute maximum ratings ($T_A = 25^\circ\text{C}$)

PARAMETER	SYMBOL	LIMIT	UNIT
Power Consumption	P_D	1000	mW
DC Forward Current (pulsed)⁽¹⁾	I_{FP}	400 ⁽²⁾	mA
DC Forward Current	I_F	300	mA
Reverse Voltage	V_R	5	V
Junction Temperature	T_j	125	$^\circ\text{C}$
Solder Point Temperature⁽³⁾	T_s	105	$^\circ\text{C}$
Operating Temperature	T_{opr}	-40 ~ +85	$^\circ\text{C}$
Storage Temperature	T_{stg}	-30 ~ +100	$^\circ\text{C}$
Soldering Temperature	T_{sol}	260 \pm 5 (<10s)	$^\circ\text{C}$
Reflow Cycles Allowed	-	2	-

(1). Pulse width $\leq 0.1\text{ms}$, duty $\leq 1/10$.

(2). Theoretical data.

(3). See page [Package material and dimension](#).

Chromaticity group and diagram

Chromaticity bins & coordinates

BLUE : RED	BIN	CIE 1931 COORDINATES							
		X0	Y0	X1	Y1	X2	Y2	X3	Y3
0.5 : 1	P1	0.4825	0.2000	0.4825	0.2400	0.5225	0.2400	0.5225	0.2000
0.75 : 1	P2	0.4350	0.1730	0.4350	0.2130	0.4750	0.2130	0.4750	0.1730
1 : 1	P3	0.3945	0.1510	0.3945	0.1910	0.4345	0.1910	0.4345	0.1510

CIE 1931 diagram

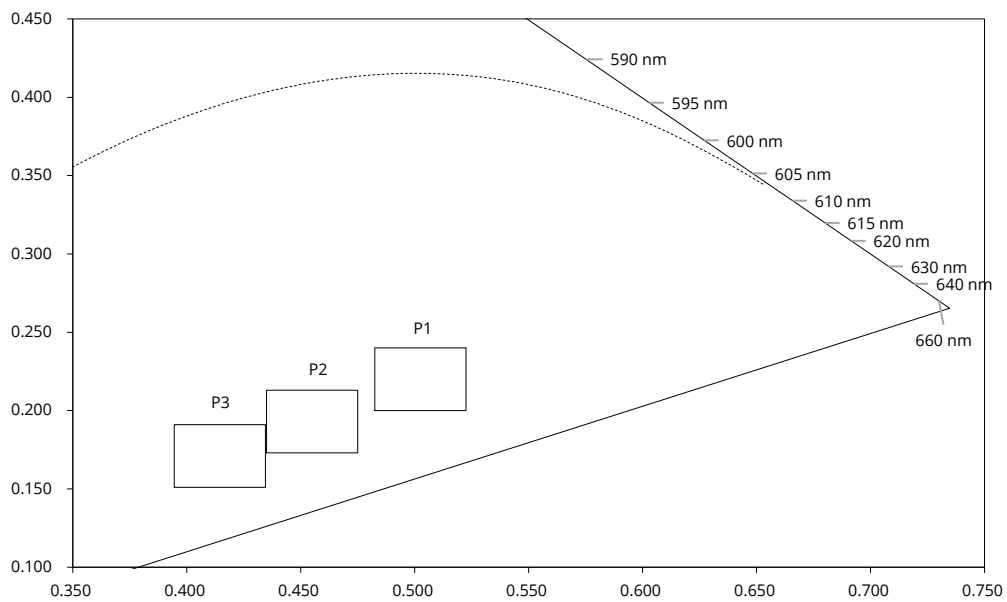

Reliability⁽¹⁾

$T_s = 55^\circ\text{C}$, $I_F = 60\text{mA}$, $\text{RH} < 65\%$, reported $L70 > 54000$ hours⁽²⁾

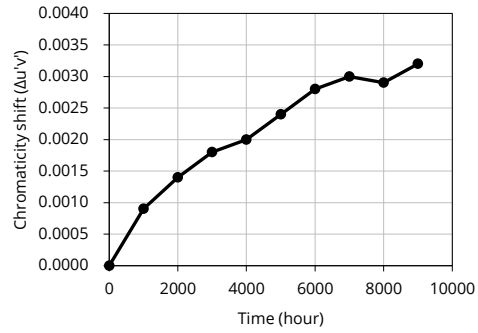
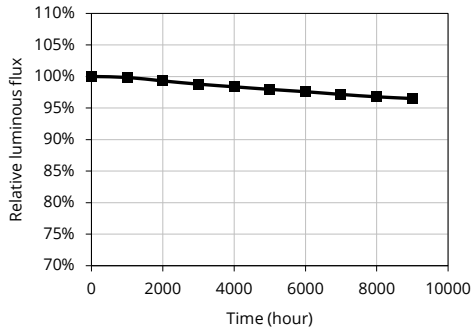

$T_s = 85^\circ\text{C}$, $I_F = 60\text{mA}$, $\text{RH} < 65\%$, reported $L70 > 54000$ hours

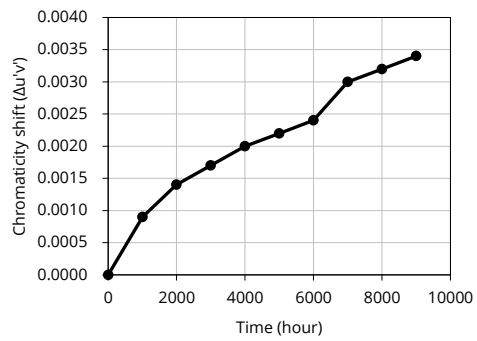
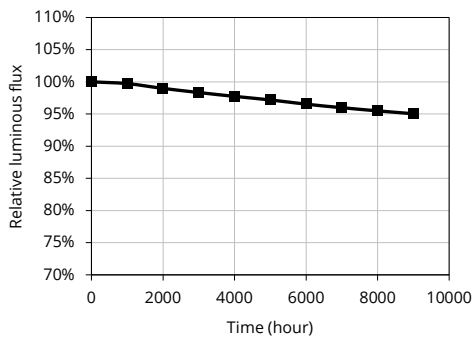

$T_s = 105^\circ\text{C}$, $I_F = 60\text{mA}$, $\text{RH} < 65\%$, reported $L70 = 52000$ hours

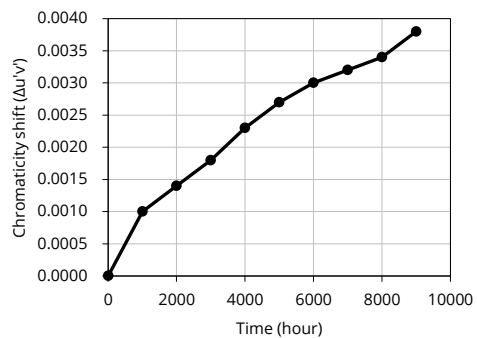
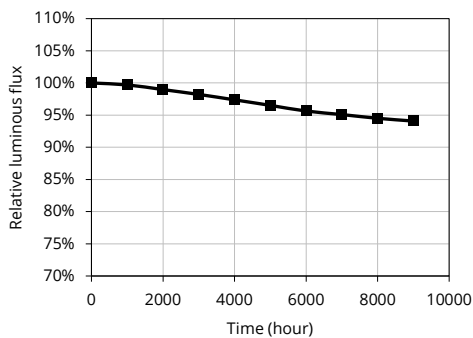

(1). Data from IESNA LM-80-2008, report number R2DG150122050-10-9000.

(2). Yujileds® reserves all the right for final explanation of reliability.

Package material and dimension

Package layout

All dimensions in mm, tolerance unless mentioned is ± 0.1 mm.

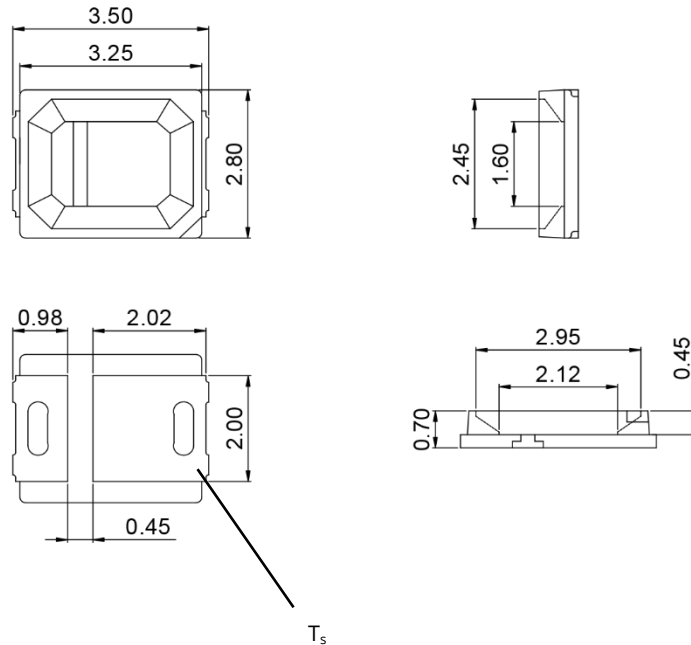

Package materials

ITEM	DESCRIPTION
Die material	InGaN
Lead frame material	PCT
Encapsulant resin material	Silicon + Phosphor
Electrodes material	Silver-plated copper

Characteristic graph

Typical spectral power distribution (normalized)

All characteristic curves are for reference only and not guaranteed.

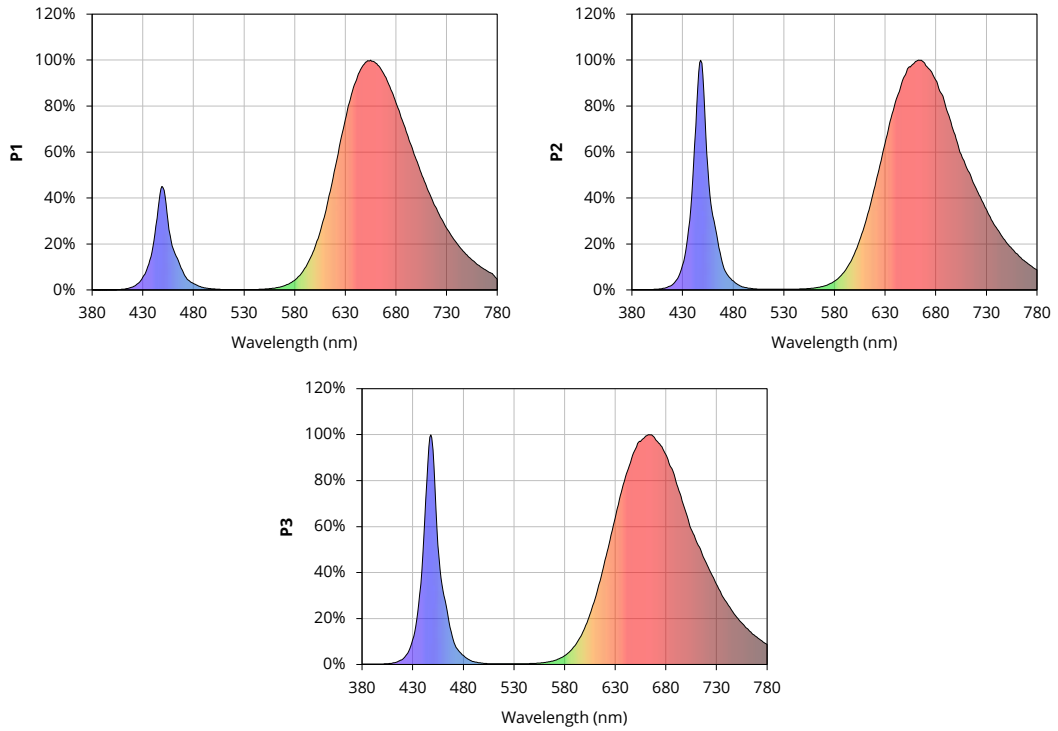

Characteristic graph

Forward current

All characteristic curves are for reference only and not guaranteed.

Vs. forward voltage

($T_A = 25^\circ\text{C}$)

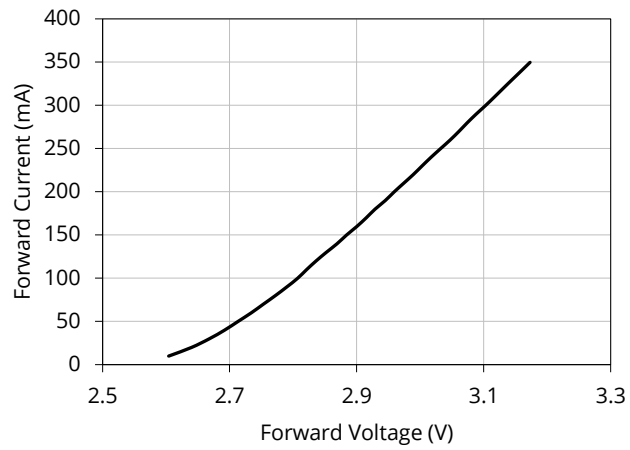

Vs. relative luminous flux

($T_A = 25^\circ\text{C}$)

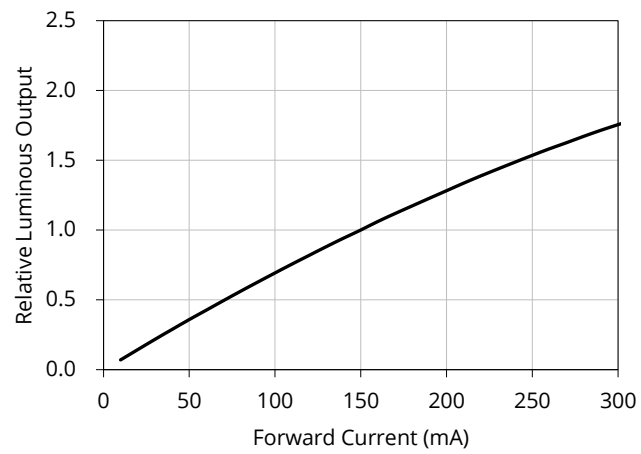

Characteristic graph

Forward current (continued)

All characteristic curves are for reference only and not guaranteed.

Vs. relative chromaticity shift

(P3, $T_A = 25^\circ\text{C}$)

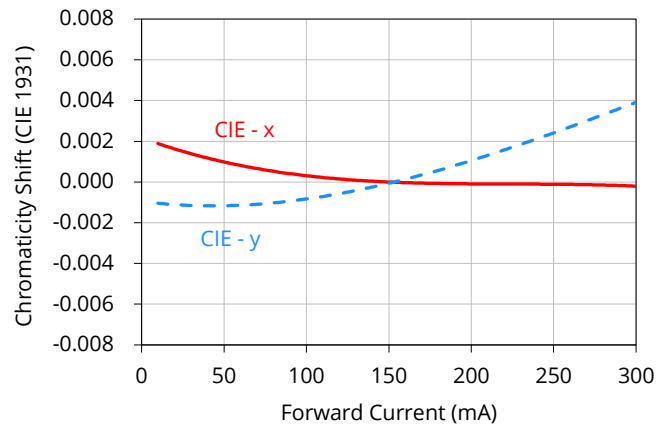

Vs. absolute chromaticity shift

(P3, $T_A = 25^\circ\text{C}$)

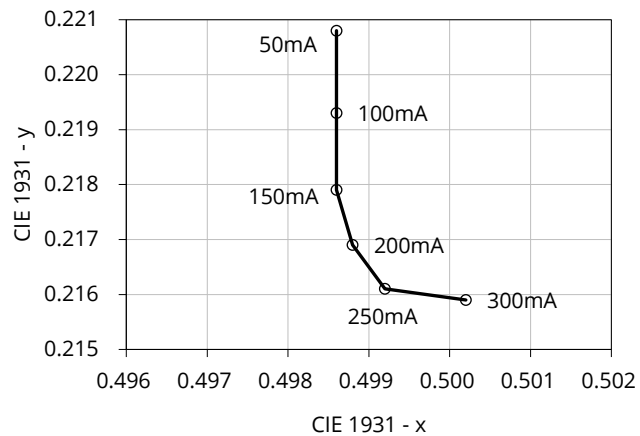

Derating based on solder point

Note: De-rating curves are meant for recommendation only and are not meant to provide guarantees of product stability and longevity.

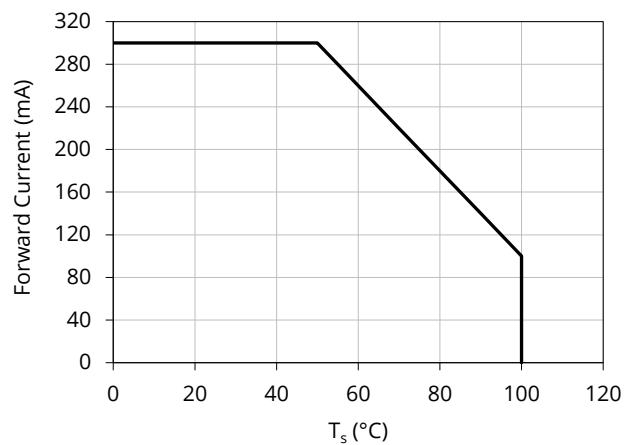

Characteristic graph

Solder point temperature (T_s)

All characteristic curves are for reference only and not guaranteed.

Vs. forward voltage

($I_F = 150\text{mA}$)

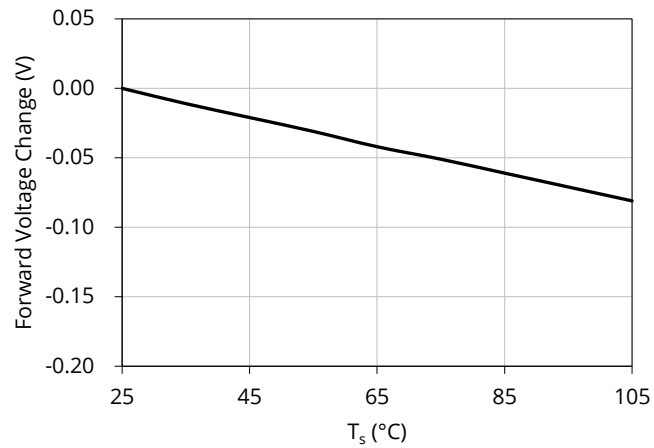

Vs. relative luminous flux

($I_F = 150\text{mA}$)

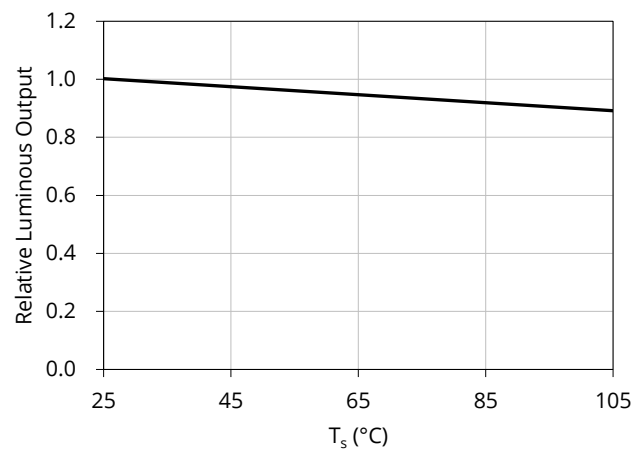

Vs. relative chromaticity shift

(P3, $I_F = 150\text{mA}$)

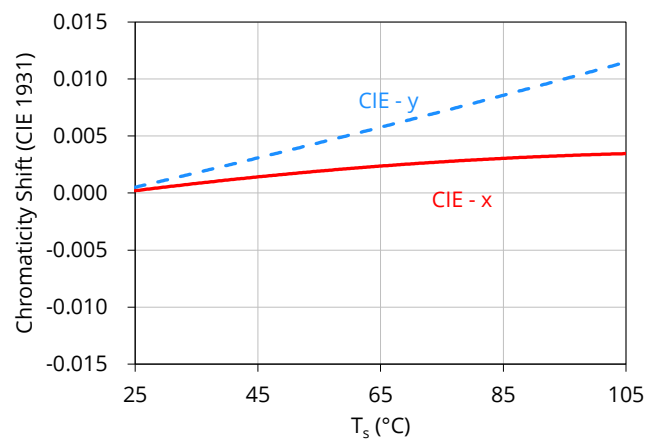

Characteristic graph

Solder point temperature (T_s) (continued)

All characteristic curves are for reference only and not guaranteed.

Vs. absolute chromaticity shift

(P3, $I_f = 150\text{mA}$)

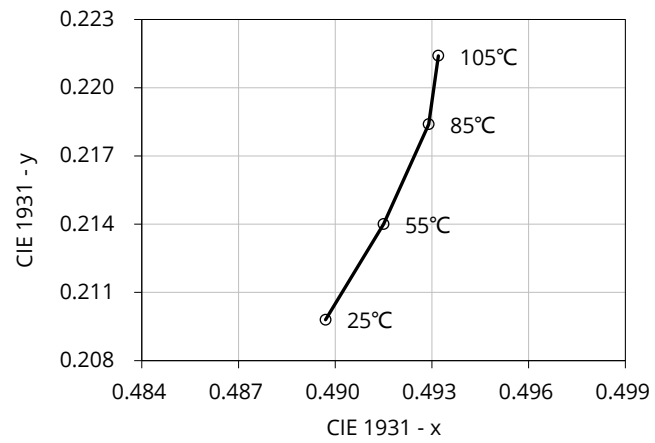

Characteristic graph

Spatial distribution ($T_A = 25^\circ\text{C}$, $I_F = 150\text{mA}$)

All characteristic curves are for reference only and not guaranteed.

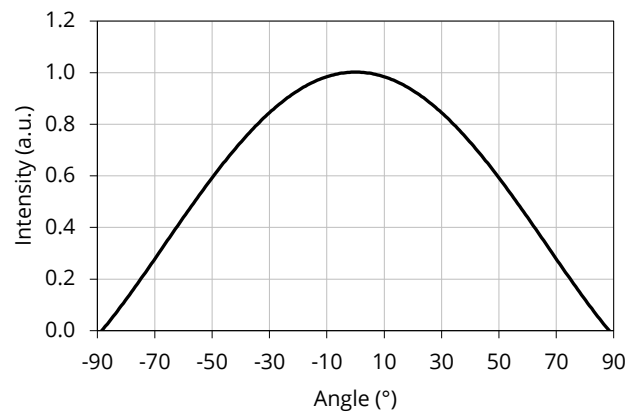

Solder and reflow profile

Recommended solder pad layout

All dimensions in mm, tolerance unless mentioned is ± 0.1 mm.

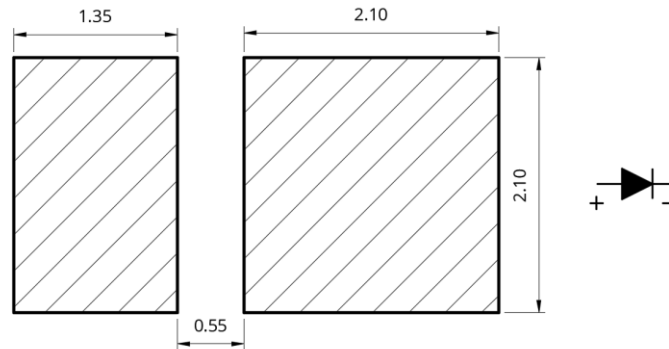

Reflow profile

Soldering ramp-up time (Pb-FREE).

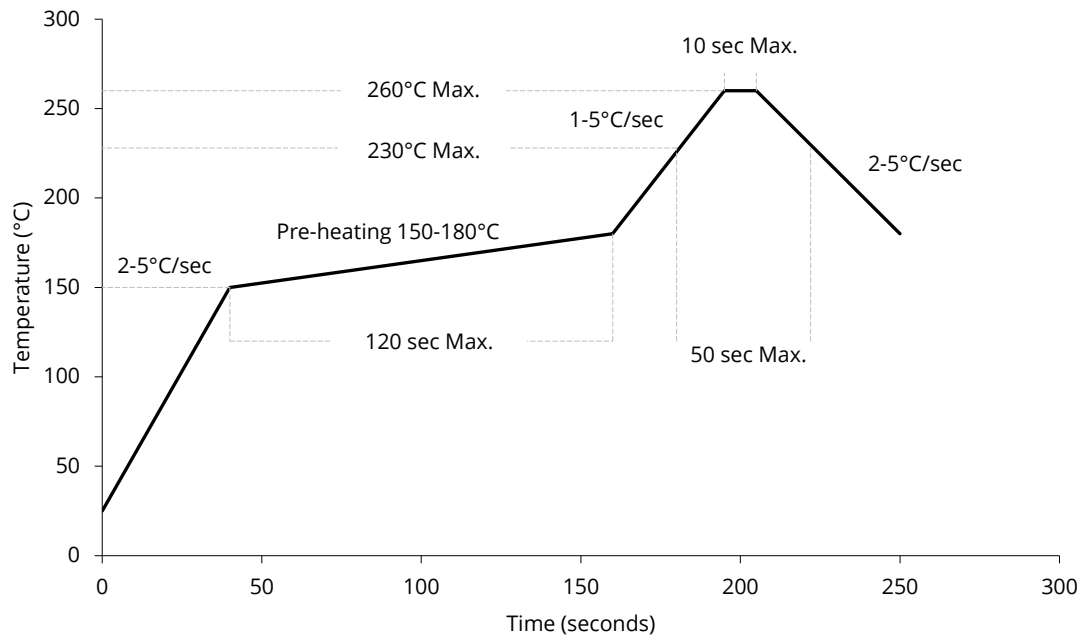

Note: Soldering paste with the melting point at 230°C is recommended.

SMT instruction

Problems caused by improper selection of collet

Choosing the right collet is important in ensuring product quality after SMT. LEDs are different from other electronic components, as they are not only concerned with electrical output but also optical output. This characteristic makes LEDs more fragile in the process of SMT. If the collet's lowering height is not well set, it will bring damage to the gold wire at the time of collet's pick-and-place process which can cause the LED to not illuminate, flicker or contribute to other quality problems, some of which may not be immediately detectable.

Collet selection

During SMT, please choose the appropriate collet in order to avoid damage the gold wire inside the LED or insufficient suction. Setting the height of the collet is crucial in order to avoid damage to the top view SMD. If the collet setting is set to too low of an altitude, the collet will press down on the SMD, causing damage or breakage to the encapsulant and cause distortion or breakage of the gold wire.

Other notes of caution

- No pressure should be exerted to the epoxy shell of the SMD under high temperature.
- Do not scratch or wipe the lens since the lens and gold wire inside are rather fragile and cross out easy to break.
- LED should be used as soon as possible when being taken out of the original package, and should be stored in anti-moisture and anti-ESD package.
- This usage and handling instructions are for reference only.

Tape and reel specifications

Tape dimensions (unit: mm)

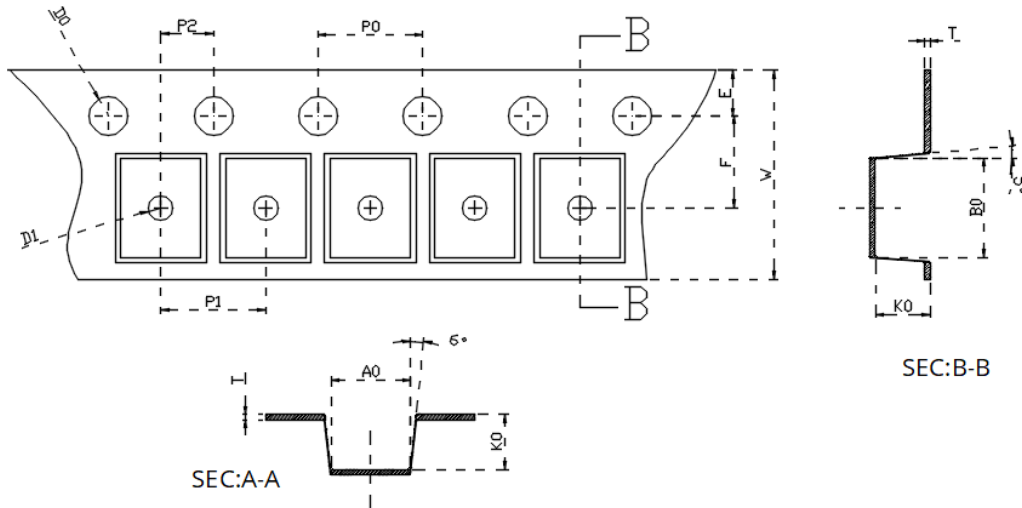

Code	W	T	D1	E	F	D0
Value	8.000	0.180	1.000	1.750	3.500	1.600
Tolerance	±0.100	±0.020	±0.100	±0.100	±0.100	±0.100
Code	P0	P1	P2	A0	B0	K0
Value	4.000	4.000	2.000	3.050	3.700	1.100
Tolerance	±0.100	±0.100	±0.100	±0.100	±0.100	±0.100

Tape layout

Not drawn to scale.

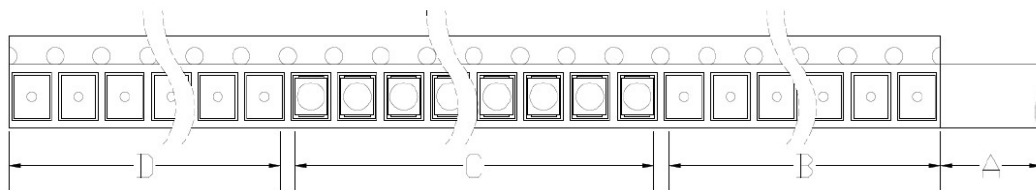

- A: Cover tape, 0mm;
- B: Empty leader, 80mm;
- C: LED, 4000pcs/5000pcs;
- D: Empty trailer, 400mm.

Tape and reel specifications

Reel dimensions top (unit: mm)

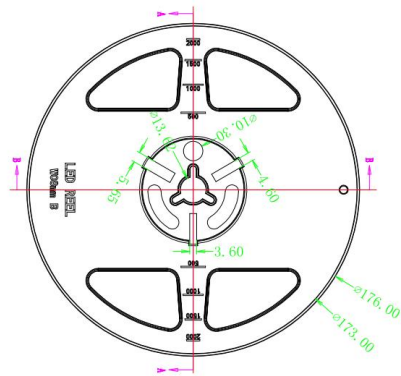

Reel dimensions bottom (unit: mm)

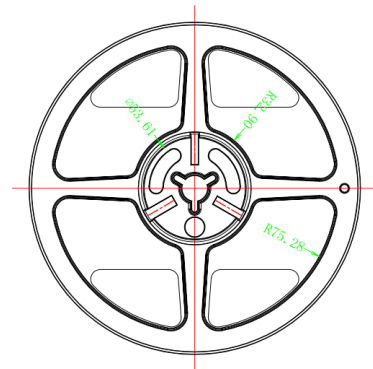

Reel dimensions side (unit: mm)

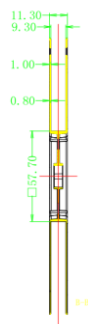

Feeding direction

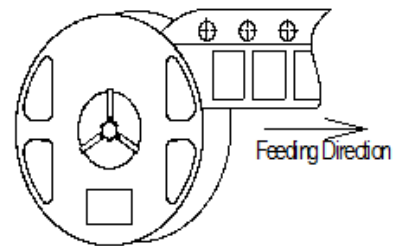

Box packaging

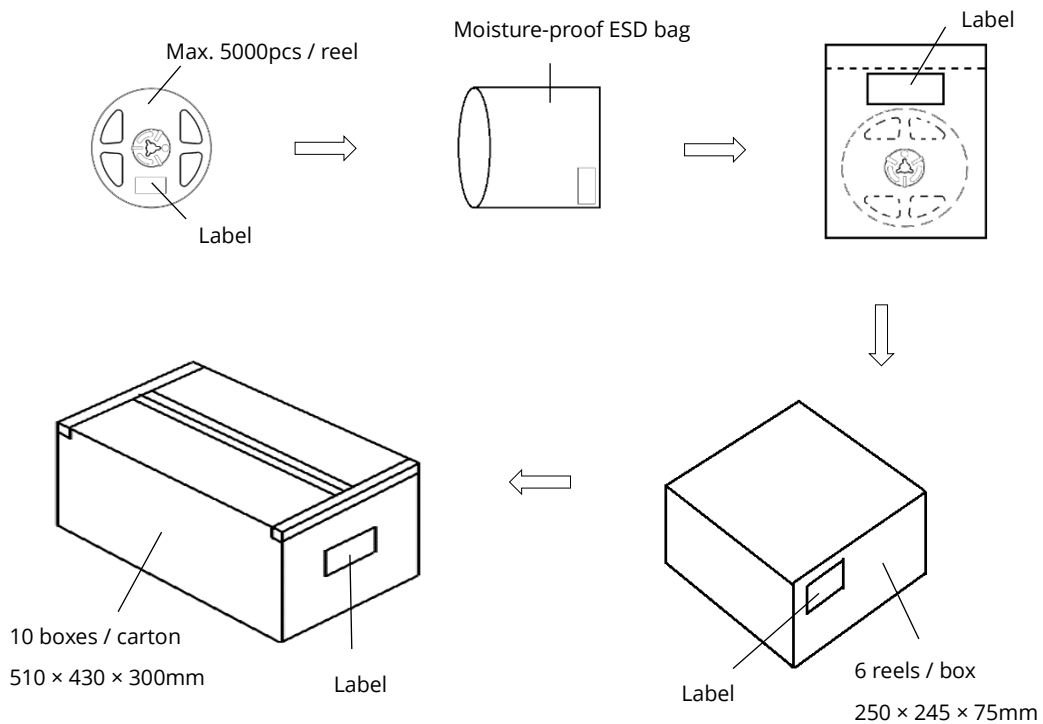

- Reeled products (max 5000 pcs / reel) are packed in a moisture-proof bag along with a moisture desiccant pack.
- Each inner box contains up to 6 moisture-proof bag (total maximum number of SMDs is 30000pcs). Box package size: 250 mm × 245 mm × 75 mm.
- Each outer package contains 10 inner boxes. Box size: 510 mm × 430 mm × 300 mm.
- Outer package is sealed with protective bubble wrap and foam. (Part numbers, lot numbers, quantity should appear on the label on the moisture-proof bag, part numbers).
- This packaging merely intended as a reference for standard quantity orders only – please note that actual packaging can differ depending on the order circumstances.

About Yujileds



Our story - Start from the superior stable red LED phosphor.

We started to make LED phosphor materials in 2006. White LEDs were still in very early stage, the industry focused on improving device brightness and efficiency via yellow phosphor very much. No one cared about the light quality. Based on this situation, we took a different approach and focused on red phosphor technology, which is the most important phosphor recipe for high CRI and/or low CCT LEDs, and it made Yuji become a JV partner with Mitsubishi Chemical from 2012.

Today, we are well known for our comprehensive research and full line-up production of LED phosphor from ultra-violet to near-infrared, and we are proud to commit to providing superior stable and efficient phosphors to the worldwide markets.

Our technology - Focus on LED spectrum innovation.

The industrial structure of both phosphor and LED gives us a unique view to develop our spectrum recipes. Compared to the general LED manufacturers, we have comprehensive information in evaluating the feasibility for both technical and commercial aspects. LED spectrum technology is not only about the quality of white LEDs, but also for different applications which have specialized requirements in lighting.

Yuji is one of the few companies that provide the service of designing or customizing a specific spectrum for clients, our confidence comes from the years of accumulation in focusing on the spectrum technologies and the control of LED phosphor and LED die supply-chain with thousands of successful cases in the past years. Innovating LED technologies and giving them commercial values are our eternal driving forces.

Our product - Yujileds®, stands for high-performance LED.

The trademark of Yujileds® is the identification of the LED products developed and manufactured by Yuji. We put our understanding of the LED technologies and the standard of our quality control into every LED we make. Regardless of any product series, we pay attention to expressing the high-performance feature and achieving the product value for clients and never compromise in pursuing the true performance.

Furthermore, we also care about every detail of any documentation we prepare for the product because we

understand the importance to transmit accurate information to clients. It is even more critical for clients to obtain the truth to decide the solution, rather than just a nominal high-performance.

Our client - Outstanding game players in different fields.

Clients are our proudest achievements, now over 200 of our clients are the best game players in their fields in more than 33 countries. We regard the clients' successes as our biggest accomplishments and appreciate their contribution in different fields, clients use our LEDs not just for simple lighting, but to design the lighting for plants, cameras, sensors, health, circadian rhythm, animals, and other industries that we have never imagined that our technologies can be utilized, that makes our work so meaningful.

Our service - Professional supporting team.

There is a group of people in Yuji passionate about creating maximum value for our clients. We have accumulated experience in different projects. Currently, the company gathers more than 30 experts from various fields of semiconductor, chemistry, optics, photoelectricity, circuitry, materials and color science.

Our sales team is well trained in deep LED technologies and has skilled global communication experience. Not just for sales, our team is more like a specialized consultancy to help every client succeed in different projects, and we do not only provide professional business service, but also support in the supply chain, logistics, marketing and technical discussions.

Contact us - We look forward to providing our efficient service for you.

LED website: www.yujiintl.com

Find Yujileds® high-performance LEDs, read our insights into a variety of advanced technologies and applications.

Contact: info@yujigroup.com

LED lighting website: www.yujilighting.com

Find our state-of-art LED lamps and luminaires designed for improving the lighting experience with the vision of illuminating the future.

Contact: lighting@yujigroup.com

Online shop: store.yujiintl.com

Shop your favorite Yuji Lighting product with rapid and professional service.

Contact: webstore@yujigroup.com