

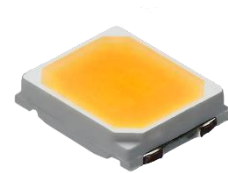

YJ-HE-2835-G02

Surface Mount Device



Applications

- High-end architectural lighting
- High-end commercial lighting

Features

- Luminous efficacy up to 210 lm/W
- 2.8mm × 3.5mm universal package
- Economical product solution
- Lifespan > 54000 hours (IES LM80)
- TLCI & TM-30 specified
- Exempt Risk Group certified (IEC 62471)
- SimpleBinning solution

[About Yujileads[®]](#)

Rev Version: 2.0

P323011.00

Table of Contents

General description	2
Ordering information	5
Characteristics	6
Chromaticity group and diagram	8
Package material and dimension	9
Characteristic graph	10
Solder and reflow profile	15
SMT instruction	16
About Yujileds	17

General description

The HE series LED is designed for creating a new era of LED with high color rendering performance and high luminous efficacy. Improving the luminous efficacy and color rendering of artificial lighting is the top need of customers. However, due to the limitations of traditional technology, if LEDs achieve high color rendering and high luminous efficacy at the same time, customers need to pay extremely high purchase costs. The new technology brought by HE series achieves high light efficacy and high color rendering while reducing costs to a competitive level.

Yujileds® HE technology, up to 210lm/W

Yujileds® HE series LED technology aims to provide the superb luminous efficacy to match the increasingly demand of energy saving for commercial lighting industry. By providing up to 210lm/W and appropriate lighting design, the HE series technology helps to achieve A-class of the latest European Product Registry for Energy Labels (EPREL) and DLC Premium.



Color quality is no longer compromised to high luminous efficacy

Technically, luminous efficacy and color rendition is contradictory and difficult to get both promising. Yujileds® HE series LED overcomes this by achieving up to 210lm/W and 90+ CRI when the general high luminous efficacy LEDs are all 80 CRI. Even for pursuing the extreme efficacy, the CRI should not be sacrificed since it is a nature of illumination quality. Even for the advanced color metric of TM-30, Yujileds® HE series LED performs the same as nominal high CRI LED with Rf 90 and Rg 99.

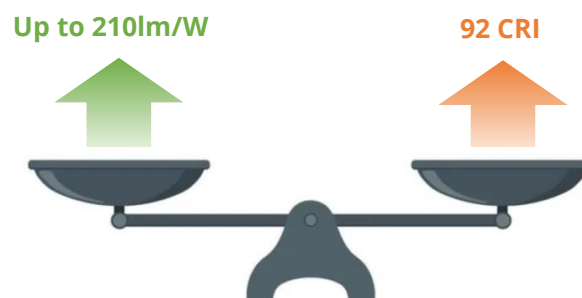

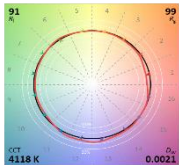
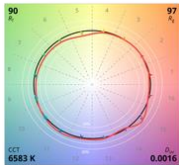
	Yujileds® HE-2835-G02	Nominal high CRI LED	Standard LED
Luminous efficacy	Up to 210lm/W	80 – 130 lm/W	130 – 200 lm/W
Fidelity index (Rf)	90	90	80
Gamut index (Rg)	99	97	95
Fidelity of 99 CES	Average 85	Average 85	Average 80
Color Vector Graphic (CVG)			

Redefine lumen per dollar (lm/\$)

For general commercial lighting, calculating lm/\$ is a common method to evaluate the economic efficiency of LED business and it becomes a measurement for commercialized competitive force. Yujileds® HE series LED provides the promising lm/\$ based on its better color quality to help customers win the business and higher profits simultaneously, thus the HE series redefines the lm/\$.

The HE series LED also supports the unique service/certification by Yujileds® as described below.



IESNA LM-80-08 certification

9000 hours data of chromaticity shift and TM-21 reported L70 lifetime at 55°C, 85°C and 105°C.

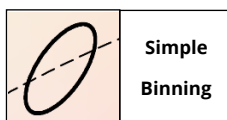

SimpleBinning specification

Simplify the chromaticity binning with TrueChroma data support to provide the most economical, simple, and practical solution to customers.



IEC 62471:2006 certification

Result in the Exempt Group (RG0) for reliable photobiological safety at the rated power.



RoHS 2011/65/EU compliance

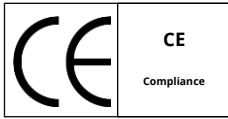

CE compliance



REACH compliance (Phosphor)

Ordering information

PART NUMBER	PRODUCT CODE	CCT	CHROMATICITY BINS	VOLTAGE RANGE
YJ-HE-2835-G02-27	P3230011.27	2700K	27A	0.1V
YJ-HE-2835-G02-30	P3230011.30	3000K	30A	0.1V
YJ-HE-2835-G02-35	P3230011.35	3500K	35A	0.1V
YJ-HE-2835-G02-40	P4230011.40	4000K	40A	0.1V
YJ-HE-2835-G02-50	P4230011.50	5000K	50A	0.1V
YJ-HE-2835-G02-XX	P4230011.XX	Custom CCT	-	0.1V

Characteristics

Electrical-optical characteristics ($T_A = 25^\circ\text{C}$, 60mA)

PARAMETER	SYMBOL	VALUE			UNIT	TOLERANCE
		MIN.	TYP.	MAX.		
Forward voltage	V_F	2.6	-	2.9	V	± 0.05
Luminous flux	Φ_{2700K}	26	-	30	lm	-
	Φ_{3000K}	27.5	-	30.5		
	Φ_{3500K}	28.5	-	31.5		
	Φ_{4000K}	29.5	-	32.5		
	Φ_{5000K}	29.5	-	32.5		
Correlated color temperature⁽¹⁾	CCT_{2700K}	2550	-	2850	K	-
	CCT_{3000K}	2850	-	3150		
	CCT_{3500K}	3350	-	3650		
	CCT_{4000K}	3800	-	4200		
	CCT_{5000K}	4800	-	5200		
Luminous efficiency	Eff_{2700K}	-	177	-	lm/W	-
	Eff_{3000K}	-	180	-		
	Eff_{3500K}	-	186	-		
	Eff_{4000K}	-	190	-		
	Eff_{5000K}	-	190	-		
Color rendering index	R_a	-	92	-	-	± 1
Reverse current	I_r	-	-	10	μA	± 0.1 ($V_r = 5V$)
View angle	$2\theta_{1/2}$	-	120	-	Deg	± 5
Thermal resistance	$R_{\theta JS}$	-	15 ⁽²⁾	-	$^\circ\text{C/W}$	-

(1). Yujileds® promises the chromaticity coordinate tolerance of ± 0.0015 (CIE 1931 x,y) based on Yuji standard equipment shall prevail.

(2). This data is for reference only.

Characteristics

Absolute maximum ratings ($T_A = 25^\circ\text{C}$)

PARAMETER	SYMBOL	LIMIT	UNIT
Power Consumption	P_D	1000	mW
DC Forward Current (pulsed)⁽¹⁾	I_{FP}	200 ⁽²⁾	mA
DC Forward Current	I_F	150	mA
Reverse Voltage	V_R	5	V
Junction Temperature	T_j	125	$^\circ\text{C}$
Solder Point Temperature⁽³⁾	T_s	105	$^\circ\text{C}$
Operating Temperature	T_{opr}	-40 ~ +85	$^\circ\text{C}$
Storage Temperature	T_{stg}	-30 ~ +100	$^\circ\text{C}$
Soldering Temperature	T_{sol}	260 \pm 5 (<10s)	$^\circ\text{C}$
Reflow Cycles Allowed	-	2	-

(1). Pulse width $\leq 0.1\text{ms}$, duty $\leq 1/10$.

(2). Theoretical data.

(3). See page [Package material and dimension](#).

Chromaticity group and diagram

Chromaticity bins & coordinates

CCT	BIN	CIE 1931 COORDINATES					SDCM	Refer to CCT
		X	Y	a	b	θ		
2700K	27A	0.4578	0.4101	0.00810	0.00420	49.70	3	2550 - 2850 K
3000K	30A	0.4338	0.4030	0.00834	0.00408	50.22	3	2850 - 3150 K
3500K	35A	0.4073	0.3917	0.00939	0.00402	54.80	3	3350 - 3650 K
4000K	40A	0.3818	0.3797	0.00939	0.00402	54.80	3	3800 - 4200 K
5000K	50A	0.3447	0.3553	0.00822	0.00354	64.12	3	4800 - 5200 K

CIE 1931 diagram

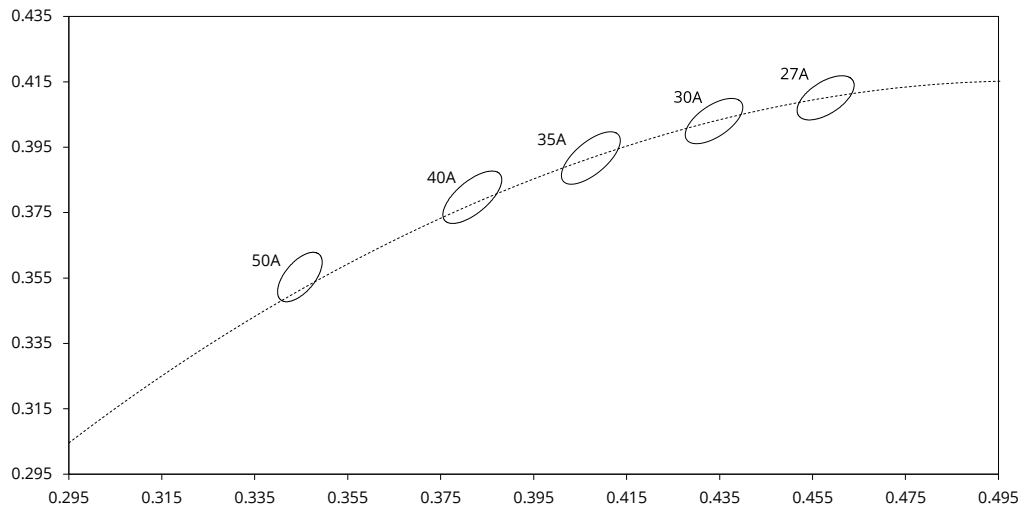

Package material and dimension

Package layout

All dimensions in mm, tolerance unless mentioned is ± 0.1 mm.

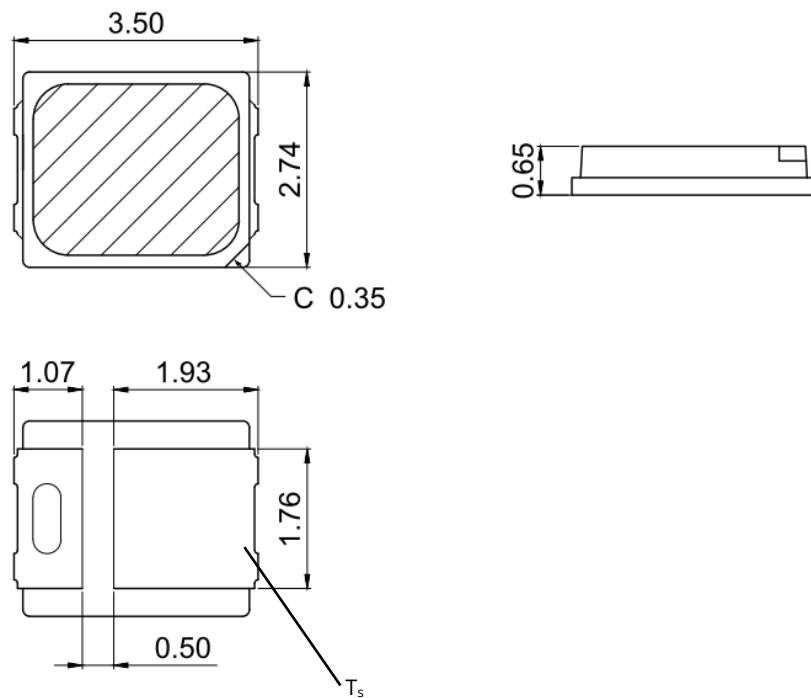

Package materials

ITEM	DESCRIPTION
Die material	GaN
Lead frame material	PCT
Encapsulant resin material	Silicon + Phosphor
Electrodes material	Silver-plated copper

Characteristic graph

Typical spectral power distribution (normalized)

All characteristic curves are for reference only and not guaranteed.

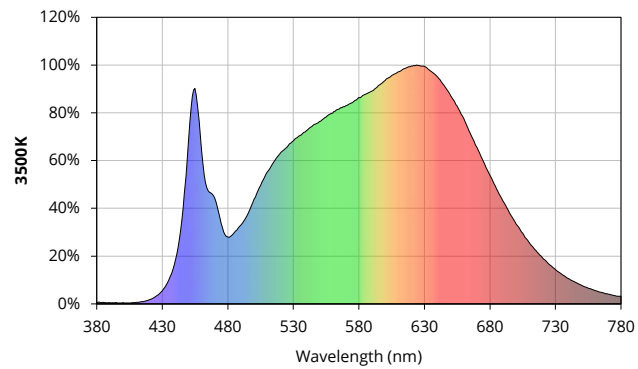

Characteristic graph

Forward current

All characteristic curves are for reference only and not guaranteed.

Vs. forward voltage

(3500K, $T_A = 25^\circ\text{C}$)

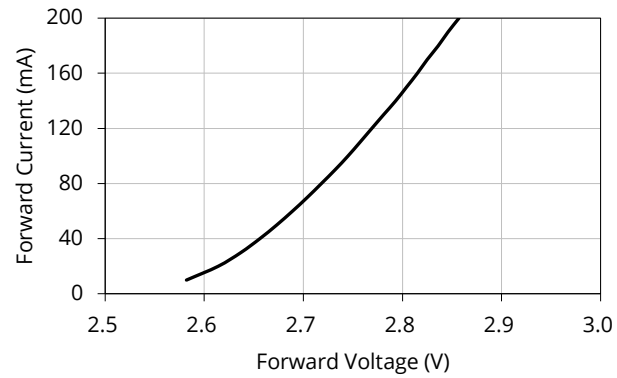

Vs. relative luminous flux

(3500K, $T_A = 25^\circ\text{C}$)

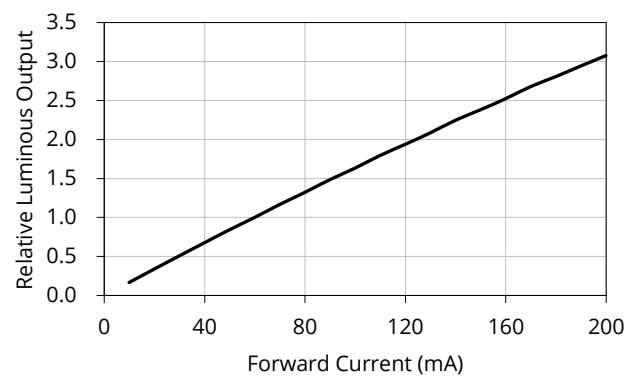

Characteristic graph

Forward current (continued)

All characteristic curves are for reference only and not guaranteed.

Vs. relative chromaticity shift

(3500K, $T_A = 25^\circ\text{C}$)

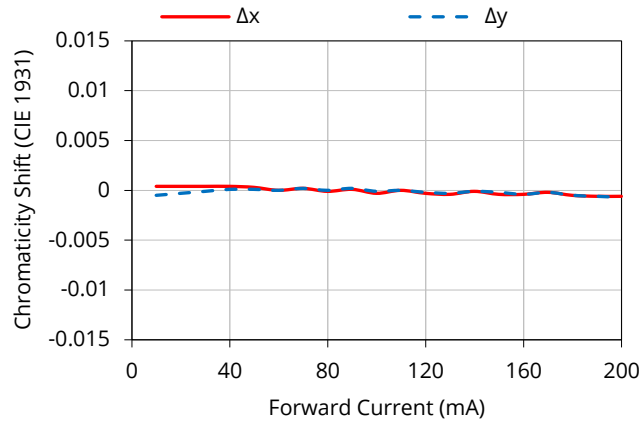

Derating based on solder point

Note: De-rating curves are meant for recommendation only and are not meant to provide guarantees of product stability and longevity.

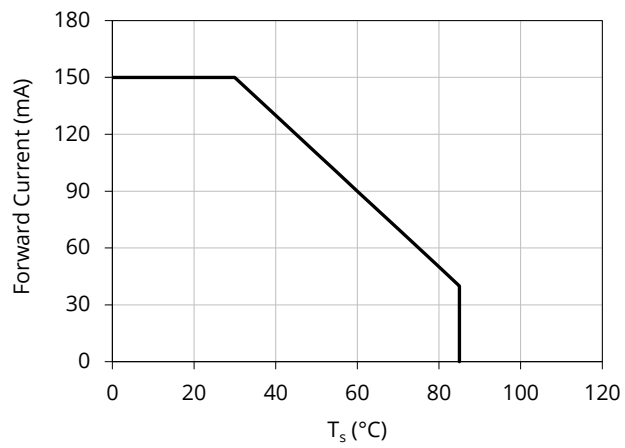

Characteristic graph

Solder point temperature (T_s)

All characteristic curves are for reference only and not guaranteed.

Vs. forward voltage

(3500K, $I_F = 60\text{mA}$)

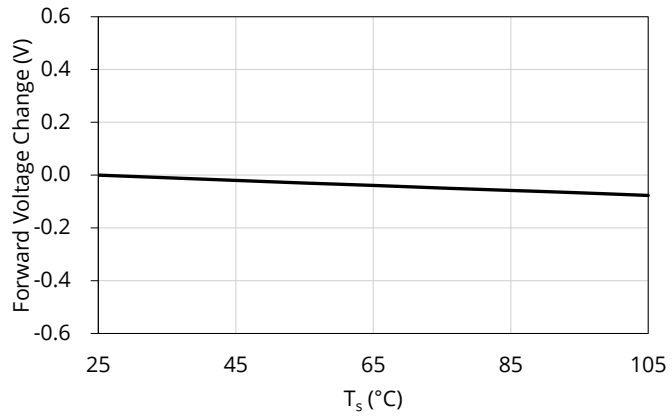

Vs. relative luminous flux

(3500K, $I_F = 60\text{mA}$)

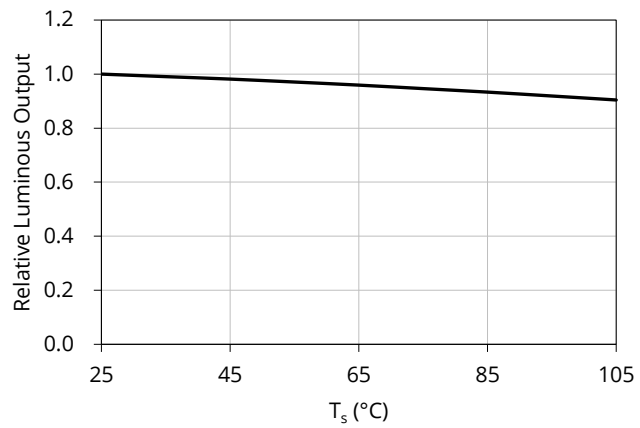

Vs. relative chromaticity shift

(3500K, $I_F = 60\text{mA}$)

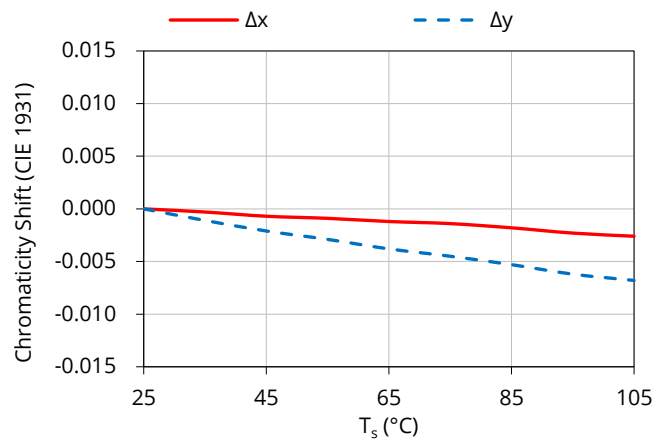

Characteristic graph

Spatial distribution ($T_A = 25^\circ\text{C}$, $I_F = 60\text{mA}$)

All characteristic curves are for reference only and not guaranteed.

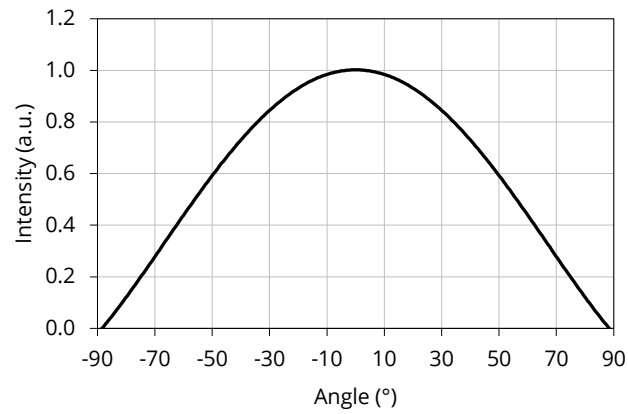

Solder and reflow profile

Recommended solder pad layout

All dimensions in mm, tolerance unless mentioned is ± 0.1 mm.

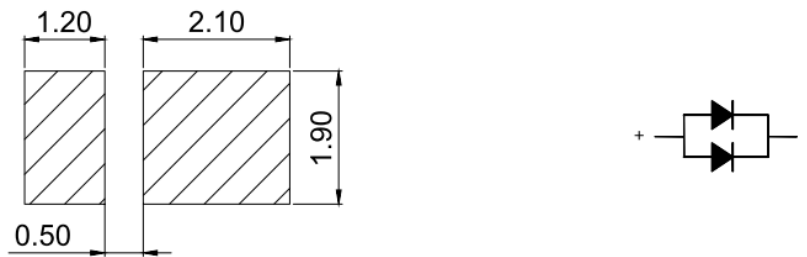

Reflow profile

Soldering ramp-up time (Pb-FREE).

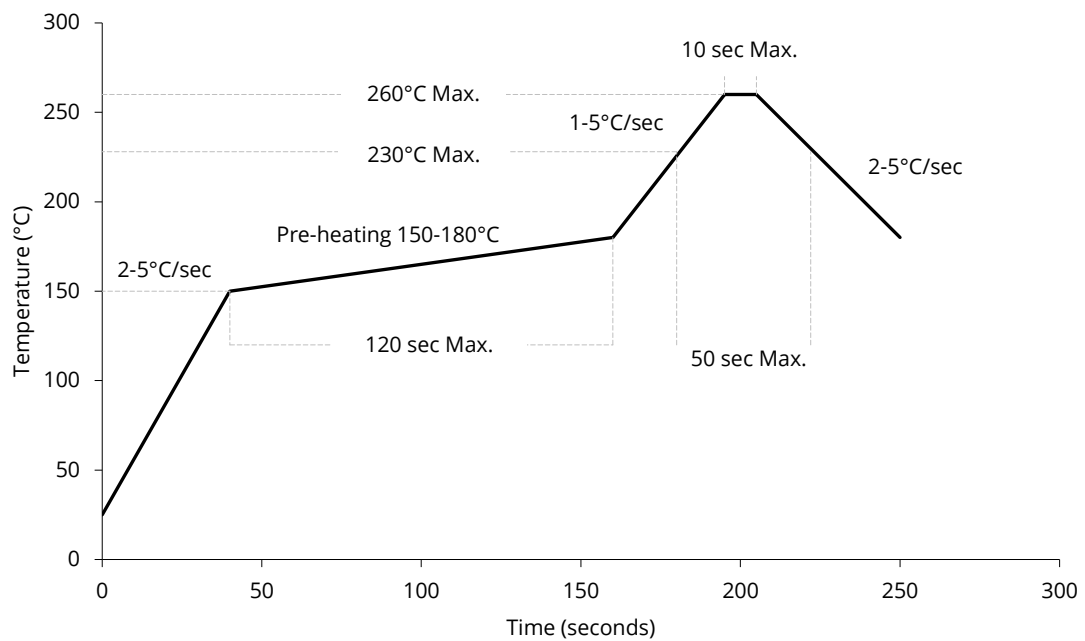

Note: Soldering paste with the melting point at 230°C is recommended.

SMT instruction

Problems caused by improper selection of collet

Choosing the right collet is important in ensuring product quality after SMT. LEDs are different from other electronic components, as they are not only concerned with electrical output but also optical output. This characteristic makes LEDs more fragile in the process of SMT. If the collet's lowering height is not well set, it will bring damage to the gold wire at the time of collet's pick-and-place process which can cause the LED to not illuminate, flicker or contribute to other quality problems, some of which may not be immediately detectable.

Collet selection

During SMT, please choose the appropriate collet in order to avoid damage the gold wire inside the LED or insufficient suction. Setting the height of the collet is crucial in order to avoid damage to the top view SMD. If the collet setting is set to too low of an altitude, the collet will press down on the SMD, causing damage or breakage to the encapsulant and cause distortion or breakage of the gold wire.

Other notes of caution

- No pressure should be exerted to the epoxy shell of the SMD under high temperature.
- Do not scratch or wipe the lens since the lens and gold wire inside are rather fragile and cross out easy to break.
- LED should be used as soon as possible when being taken out of the original package, and should be stored in anti-moisture and anti-ESD package.
- This usage and handling instructions are for reference only.

About Yujileds



Our story - Start from the superior stable red LED phosphor.

We started to make LED phosphor materials in 2006. White LEDs were still in very early stage, the industry focused on improving device brightness and efficiency via yellow phosphor very much. No one cared about the light quality. Based on this situation, we took a different approach and focused on red phosphor technology, which is the most important phosphor recipe for high CRI and/or low CCT LEDs, and it made Yuji become a JV partner with Mitsubishi Chemical from 2012.

Today, we are well known for our comprehensive research and full line-up production of LED phosphor from ultra-violet to near-infrared, and we are proud to commit to providing superior stable and efficient phosphors to the worldwide markets.

Our technology - Focus on LED spectrum innovation.

The industrial structure of both phosphor and LED gives us a unique view to develop our spectrum recipes. Compared to the general LED manufacturers, we have comprehensive information in evaluating the feasibility for both technical and commercial aspects. LED spectrum technology is not only about the quality of white LEDs, but also for different applications which have specialized requirements in lighting.

Yuji is one of the few companies that provide the service of designing or customizing a specific spectrum for clients, our confidence comes from the years of accumulation in focusing on the spectrum technologies and the control of LED phosphor and LED die supply-chain with thousands of successful cases in the past years. Innovating LED technologies and giving them commercial values are our eternal driving forces.

Our product - Yujileds®, stands for high-performance LED.

The trademark of Yujileds® is the identification of the LED products developed and manufactured by Yuji. We put our understanding of the LED technologies and the standard of our quality control into every LED we make. Regardless of any product series, we pay attention to expressing the high-performance feature and achieving the product value for clients and never compromise in pursuing the true performance.

Furthermore, we also care about every detail of any documentation we prepare for the product because we understand the importance to transmit accurate information to clients. It is even more critical for clients to obtain

the truth to decide the solution, rather than just a nominal high-performance.

Our client - Outstanding game players in different fields.

Clients are our proudest achievements, now over 200 of our clients are the best game players in their fields in more than 33 countries. We regard the clients' successes as our biggest accomplishments and appreciate their contribution in different fields, clients use our LEDs not just for simple lighting, but to design the lighting for plants, cameras, sensors, health, circadian rhythm, animals, and other industries that we have never imagined that our technologies can be utilized, that makes our work so meaningful.

Our service - Professional supporting team.

There is a group of people in Yuji passionate about creating maximum value for our clients. We have accumulated experience in different projects. Currently, the company gathers more than 30 experts from various fields of semiconductor, chemistry, optics, photoelectricity, circuitry, materials and color science.

Our sales team is well trained in deep LED technologies and has skilled global communication experience. Not just for sales, our team is more like a specialized consultancy to help every client succeed in different projects, and we do not only provide professional business service, but also support in the supply chain, logistics, marketing and technical discussions.

Contact us - We look forward to providing our efficient service for you.

LED website: www.yujiintl.com

Find Yujileds® high-performance LEDs, read our insights into a variety of advanced technologies and applications.

Contact: info@yujigroup.com

LED lighting website: www.yujilighting.com

Find our state-of-art LED lamps and luminaires designed for improving the lighting experience with the vision of illuminating the future.

Contact: lighting@yujigroup.com

Online shop: store.yujiintl.com

Shop your favorite Yuji Lighting product with rapid and professional service.

Contact: webstore@yujigroup.com